

# **Zebra® ZXP Series 8™ Card Printer**

## **User's Manual**

## Copyright Notice

© 2010 ZIH Corp.

This document contains information proprietary to Zebra Technologies Corporation. This document and the information contained within is Copyrighted by Zebra Technologies Corporation and may not be duplicated in full or in part by any person without written approval from Zebra.

While every effort has been made to keep the information contained within current and accurate as of the date of publication, no guarantee is given that the document is error-free or that it is accurate with regard to any specification. Zebra Technologies Corporation reserves the right to make changes, for the purpose of product improvement, at any time.

## Trademarks

ZXP Series 8 is a trademark and Zebra is a registered trademark of Zebra Technologies Corporation. Windows is a registered trademark of Microsoft Corporation in the United States and other countries. All other trademarks or registered trademarks are marks of their respective holders.

## Product Disposal



**Product Disposal Information** • Do not dispose of this product in unsorted municipal waste. This product is recyclable, and should be recycled according to your local standards. For more information, please see our web site at:  
<http://www.zebra.com/environment>

---

# Contents



<b>1 • Introduction</b> .....	<b>1</b>
Components .....	2
Controls, Connectors, and Indicators .....	4
Icons .....	5
Zebra Supplies .....	5
<b>2 • Installation and Setup</b> .....	<b>7</b>
General Information .....	7
Unpacking the Printer .....	8
Installing the Card Hoppers .....	10
Loading Cards .....	11
Opening the Printer Door .....	12
Installing the Card Cleaning Cartridge .....	13
Installing the Card Cleaning Roller .....	14
Loading the Transfer Film .....	15
Loading a Print Ribbon .....	17
Connecting Power .....	19
Connecting the Printer to your Computer .....	20
Installing the Windows Printer Driver .....	22
<b>3 • Operation</b> .....	<b>35</b>
Introduction .....	35
Card Type Selection .....	36
Printing a Sample Card .....	37
Manual Card Feed .....	38
Operator Control Panel (OCP) .....	40
Ethernet Indicators -- Detail .....	49

<b>4 • Printer Settings and Adjustments</b> .....	<b>51</b>
Introduction .....	51
Properties .....	52
Printing Preferences .....	60
<b>5 • ZXP Series Toolbox</b> .....	<b>71</b>
Introduction .....	71
ZXP Series Toolbox Access .....	72
Information .....	73
Configuration .....	76
Cleaning .....	83
Print Test Card .....	85
Technology .....	86
Advanced Security .....	88
Print Viewer .....	91
<b>6 • Cleaning</b> .....	<b>93</b>
Cleaning the Printer .....	93
Cleaning the Printhead .....	97
Card Cleaning Cartridge .....	98
Card Cleaning Roller .....	98
<b>7 • Troubleshooting</b> .....	<b>99</b>
OCP Error Messages .....	100
OCP Test Card Images .....	107
Test Card Descriptions .....	108
Ethernet Issues .....	109
<b>8 • Technical Specifications</b> .....	<b>111</b>
Standard Features .....	111
Specifications .....	112
Declarations of Conformity .....	115
<b>Appendix A • Printer Configurations</b> .....	<b>117</b>
<b>Appendix B • Setting Custom Card Specifications</b> .....	<b>119</b>
<b>Appendix C • Network Operations</b> .....	<b>161</b>
<b>Appendix D • Magnetic Card Encoder</b> .....	<b>171</b>
<b>Appendix E • Smart Card Options</b> .....	<b>179</b>
<b>Appendix F • Packing the Printer for Shipment</b> .....	<b>185</b>
<b>Appendix G • Worldwide Support</b> .....	<b>187</b>



---

# Introduction

This manual contains installation and operation information for the Zebra ZXP Series 8 Card Printers manufactured by Zebra Technologies Corporation.

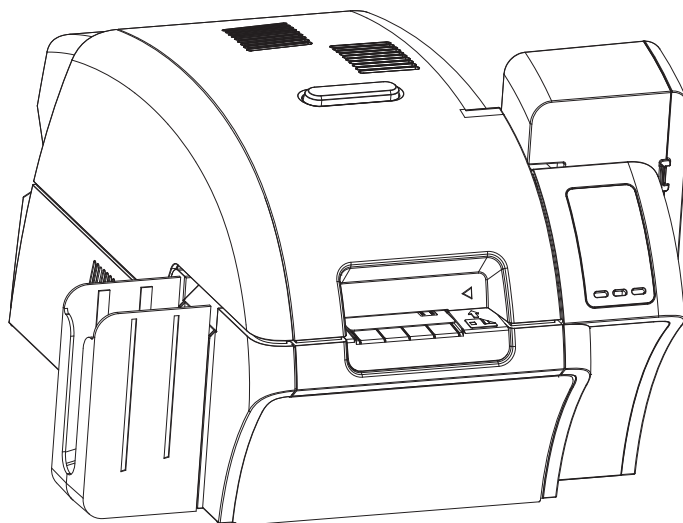

The Zebra ZXP Series 8 Card Printers use reverse transfer printing technology to create photo-quality and over-the-edge images on plastic identification cards.

Zebra's reverse transfer printers provide fast throughput and a range of encoding options for a variety of markets and applications.

## Components

### Front View, Covers Closed

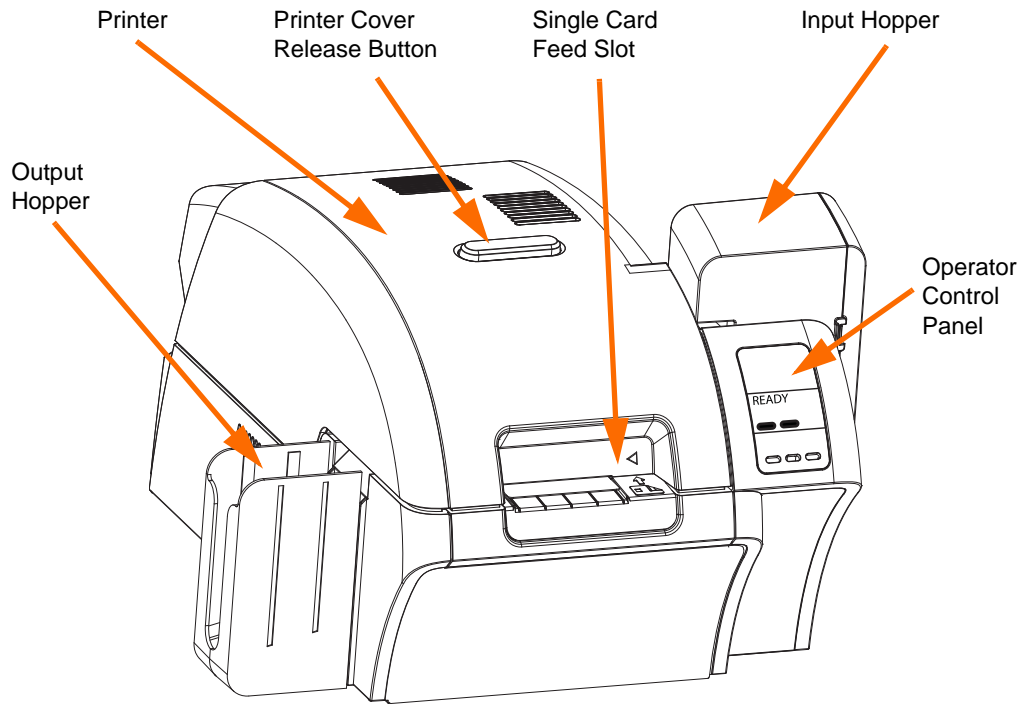

## Front View, Printer Cover Open

The following figure shows components of the printer.

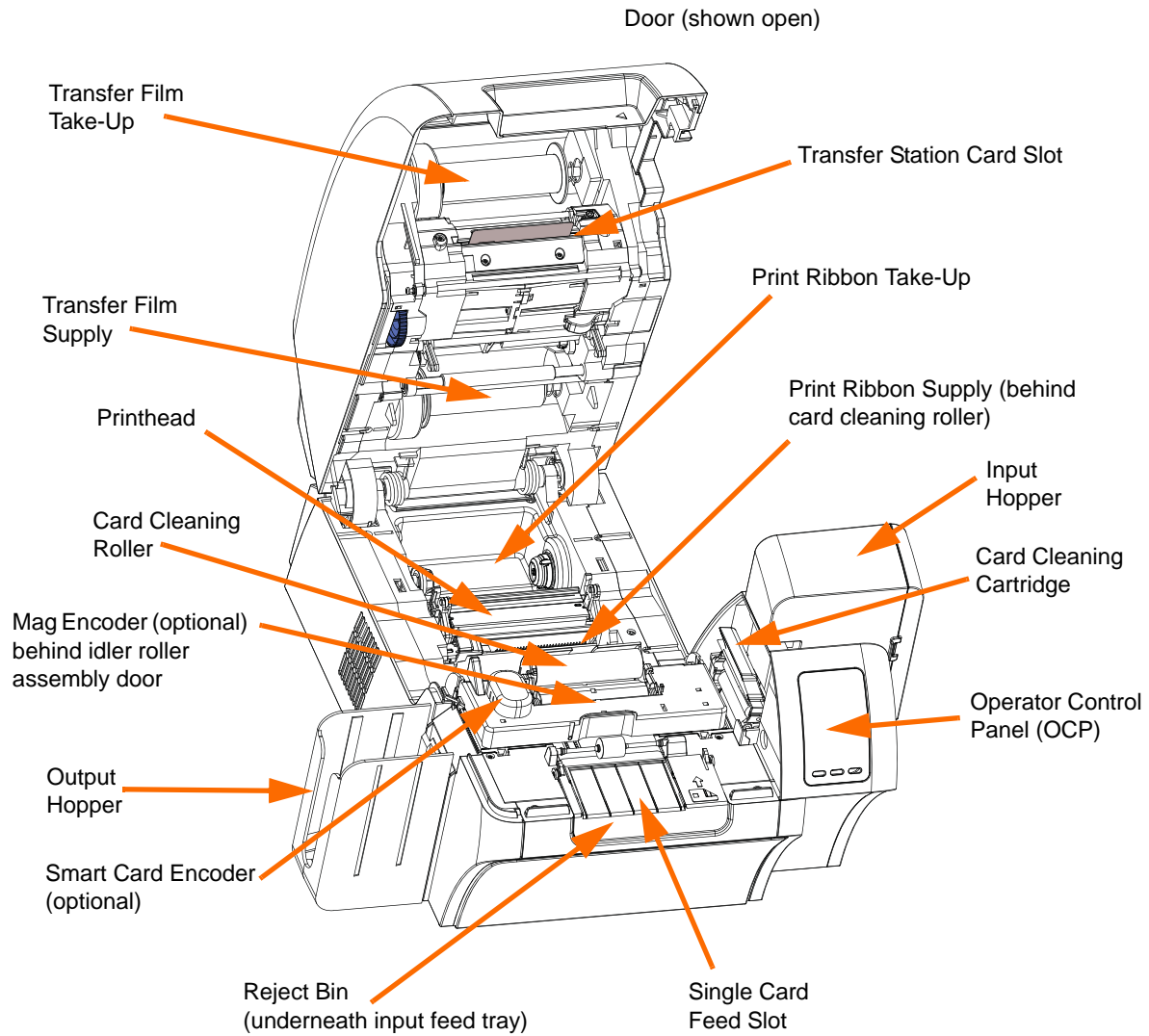

## Controls, Connectors, and Indicators

Your printer has an OCP Display and three OCP Buttons on the front and a power connector, power switch, and interface connector(s) on the rear panel.

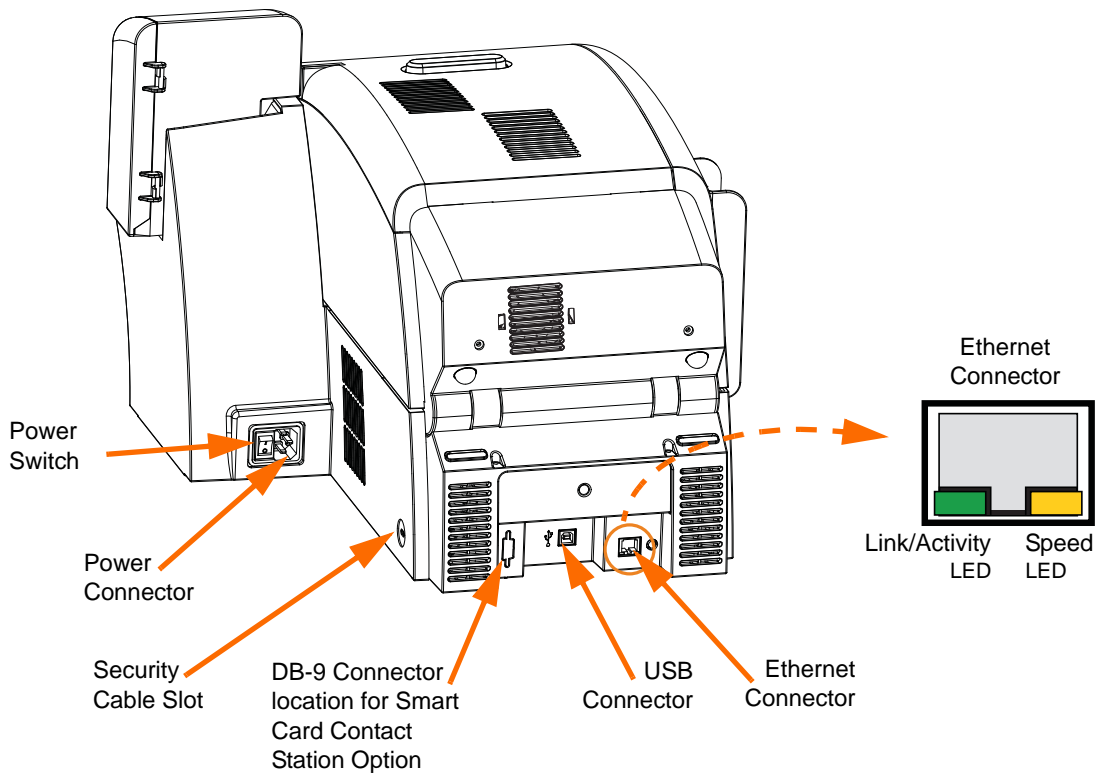
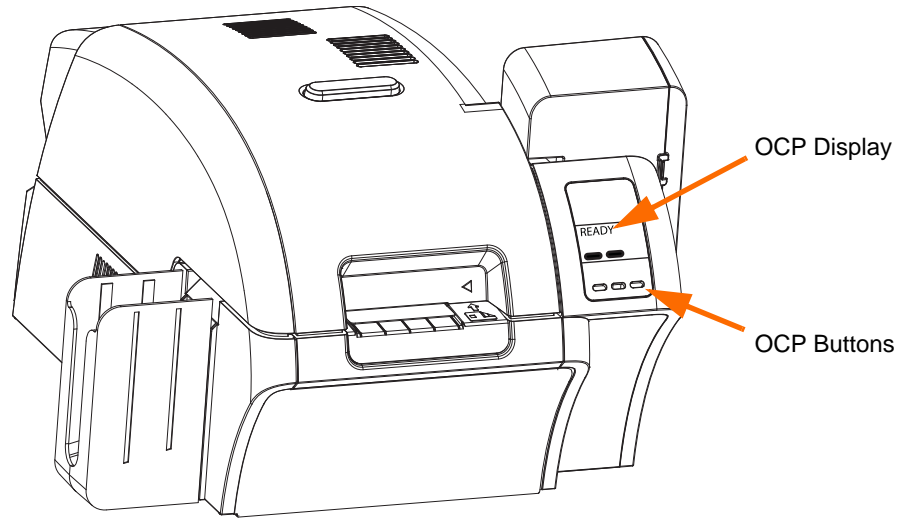



## Icons

Throughout this manual, different icons highlight important information, as follows:



**Note** • Indicates information that emphasizes or supplements important points of the main text.



**Important** • Advises you of information that is essential to complete a task, or points out the importance of specific information in the text.



Provides an example or scenario to demonstrate or clarify a section of text.



---

**Electrostatic Discharge Caution** • Warns you of the potential for electrostatic discharge.

---



---

**Electric Shock Caution** • Warns you of a potential electric shock situation.

---



---

**Hot Surface** • Warns you of a situation where excessive heat could cause a burn.

---



---

**Caution** • Advises you that failure to take or avoid a specific action could result in physical harm to you, or could result in physical damage to the hardware.

---

## Zebra Supplies

Genuine Zebra supplies meet stringent quality standards and are recommended for optimal printing quality and proper printer performance. The ZXP Series 8 printer is designed to work only with Zebra True Colours® i Series™ Ribbons and True Colours™ i Series™ Transfer Film.

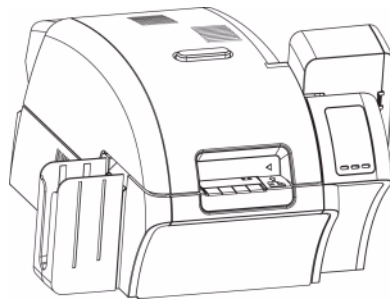



---

# Installation and Setup

## General Information

This section will guide you through the installation and setup of your Card Printer. This consists of the following procedures, which should be performed in the order presented.

- Unpacking the Printer..... 8
- Installing the Card Hoppers ..... 10
- Loading Cards ..... 11
- Opening the Printer Door..... 12
- Installing the Card Cleaning Cartridge..... 13
- Installing the Card Cleaning Roller ..... 14
- Loading the Transfer Film ..... 15
- Loading a Print Ribbon ..... 17
- Connecting Power ..... 19
- Connecting the Printer to your Computer ..... 20
- Installing the Windows Printer Driver ..... 22

The procedure to be followed for Packing the Printer for Shipment is given at the end of this section.

## Unpacking the Printer

**Step 1.** Inspect the shipping container to ensure that no damage has occurred during shipment. If any damage is apparent, file a claim with the shipper.

**Step 2.** Open the shipping container.

**Step 3.** Remove the packing material and accessories.



**Important •** Save all the packing material and the shipping carton in case the Printer needs to be moved or shipped. If the original material is lost or damaged, a replacement Shipping Kit can be ordered from Zebra.

**Step 4.** Make sure the following items are included with your Printer:

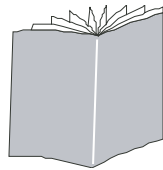

Quick Start Guide

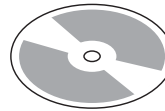

CD-ROM with InstallWizard

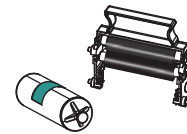

Cleaning Cartridge



Cleaning Roller

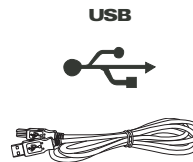

USB Cable



Power Cable

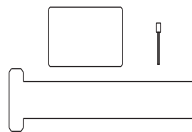

Cleaning Kit

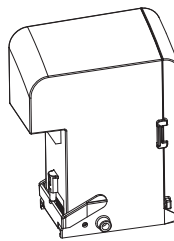

Input Hopper

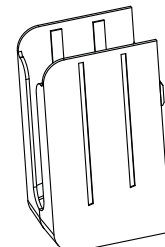

Output Hopper

If any items are missing, please contact your dealer. To reorder, please refer to [Appendix G](#) of this manual.



---

**Caution** • The Printer weighs approximately 27.5 lbs (12.5 kg).

---

**Step 5.** Lift the Printer out of the carton by holding it with both hands.

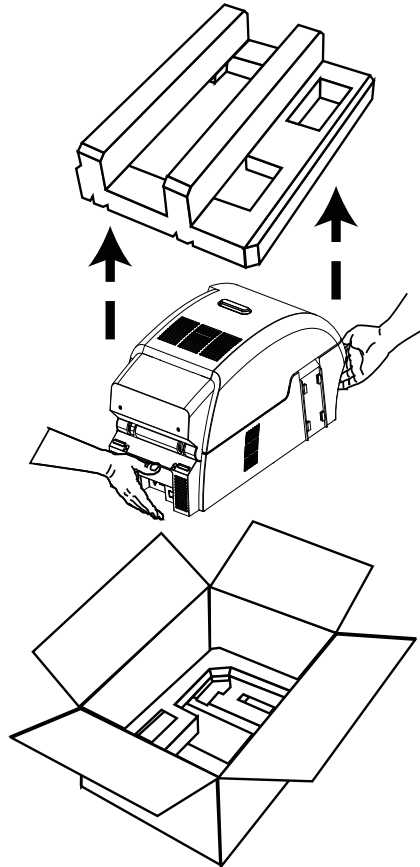

**Step 6.** Place the Printer in a location that meets the following requirements:

- A reasonably dust- and dirt-free environment.
- Flat surface at least 27 in (686 mm) x 28 in (711 mm) that can support the weight of the Printer; additional space preferred. Allow a 4-inch clearance, minimum, on all sides.
- Vertical clearance at least 32 in (813 mm).
- Temperature within the range of 59° to 77°F (15° to 25°C).
- Relative Humidity 20 to 80% inclusive, non-condensing.
- AC power accessible.

**Step 7.** Remove the protective plastic bag from the Printer.

## Installing the Card Hoppers

### Input Hopper

The Input Hopper is positioned on the right side of the Printer and holds the cards to be printed.

- Step 1.** Install the Input Hopper by sliding the hopper into the receptacle on the right side of the Printer.
- Step 2.** Ensure that the Input Hopper locks securely in place.

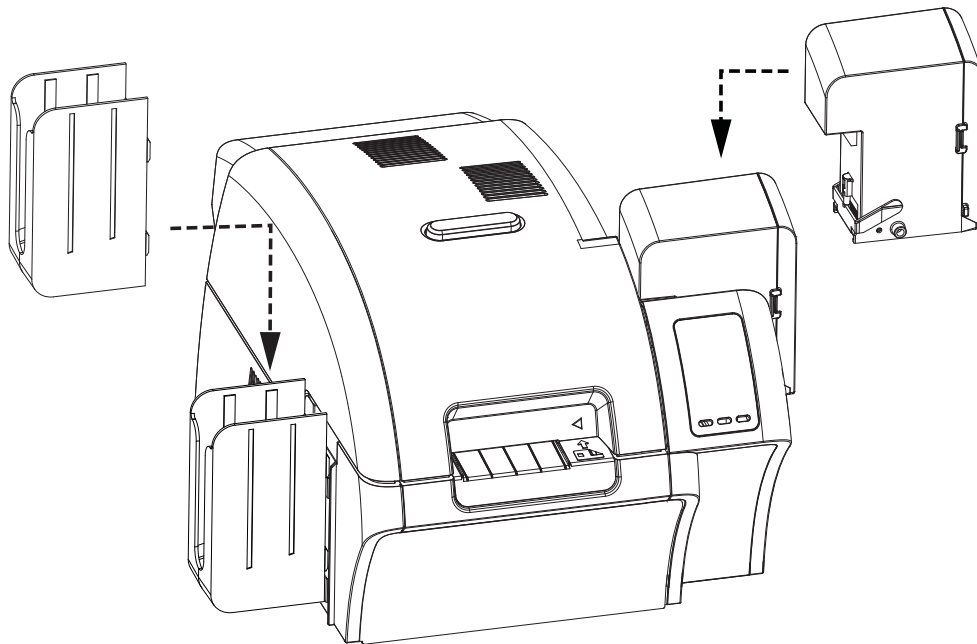

### Output Hopper

The Output Hopper is positioned on the left side of the Printer and receives the printed cards.

- Step 1.** Install the Output Hopper by inserting the four tabs on the right side of the hopper into the four slots on the left side of the Printer.
- Step 2.** Ensure that the Output Hopper locks securely in place.

## Loading Cards



---

**Caution • DO NOT bend cards or touch print surfaces** as this can reduce print quality. The surface of the cards must remain clean and dust free. Always store cards in an enclosed container. Ideally, use cards as soon as possible.

---

**Step 1.** Remove the wrapping from the card deck.

**Step 2.** Holding the card deck by the sides (**do not touch the print surfaces**), hold it vertically against a flat surface such as a desktop. If the deck is too thick for your hand to hold it comfortably, use about half a deck at a time.

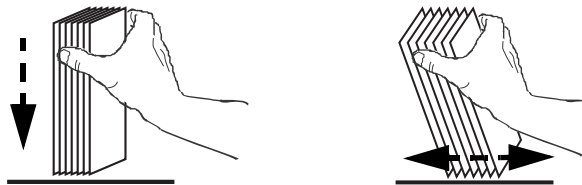

**Step 3.** Push the stack back and forth to an angle of about 45° from vertical, so as to separate all of the cards.



**Note •** Static charges and edge burrs from the card die-cutting process can render individual cards stuck together with significant adhesion force. These cards *must be* physically separated from each other before inserting into the feeder; if not separated, feeding or printing problems may occur.

**Step 4.** Restore the card stack to its original squared-off condition.

**Step 5.** Open the Input Hopper Door.

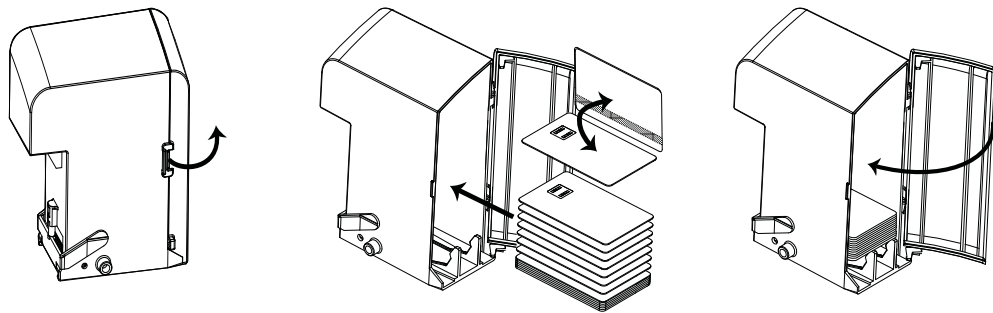

**Step 6.** Place the cards in the Input Hopper in the orientation as shown (smartcard contacts, if present, up and toward the body of the printer; mag stripe, if present, down and to the rear). Ensure that the cards are seated flat on the bottom of the hopper.

**Step 7.** Close the Input Hopper Door.

## Opening the Printer Door

**Step 1.** Press the Door Release button on the top of the Printer.

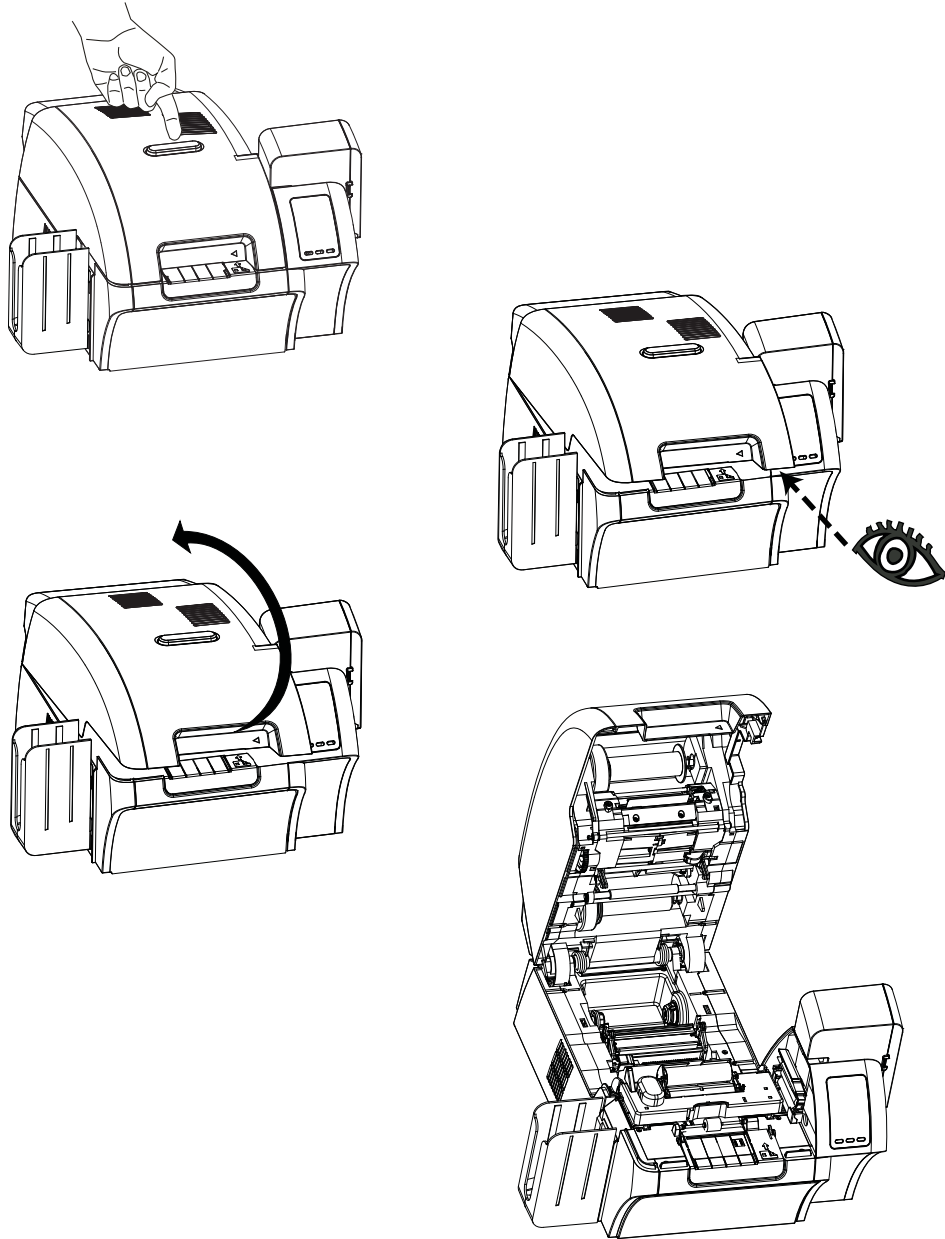

**Step 2.** Observe that the Door releases and pops up approximately half an inch.

**Step 3.** Grasp the Door at the bottom front.

**Step 4.** Lift the Door to its upright position. It will remain in that position.



## Installing the Card Cleaning Cartridge

The Card Cleaning Cartridge cleans the cards entering the Printer from the Input Hopper. The Card Cleaning Cartridge consists of a Cartridge Frame and an Adhesive Roller, which are packed together.

- Step 1.** Remove the Cartridge Frame and the Adhesive Roller from their packaging.
- Step 2.** Insert the Adhesive Roller into the Cartridge Frame. To avoid contamination, always hold the frame and the roller by the ends.
- Step 3. Peel the protective wrapper from the Adhesive Roller.**
- Step 4.** Open the Printer Door by pressing the Door Release button on the top of the Printer.
- Step 5.** Locate the area where the Card Cleaning Cartridge will be installed (adjacent to the Input Hopper); circled below.

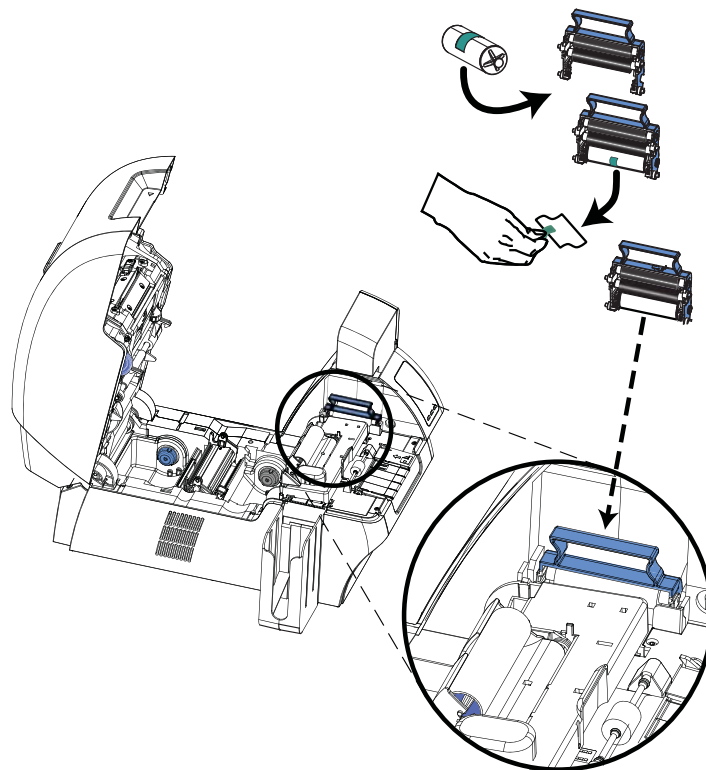

- Step 6.** Hold the Card Cleaning Cartridge by the extended handle.
- Step 7.** With the cartridge at about a 30° angle (pointing downward), insert the lip of the cartridge into the slot, until the cartridge seats against the back wall.
- Step 8.** Press the front of the cartridge down until it seats all the way down and latches.
- Step 9.** Close the Printer's Door.

## Installing the Card Cleaning Roller

The Card Cleaning Roller cleans the cards entering the Printer from either the Input Hopper or the Single-Feed Input.

- Step 1.** Remove the Card Cleaning Roller from its packaging. To avoid contamination, always hold the roller by the ends.
- Step 2.** Peel the protective wrapper from the Card Cleaning Roller.
- Step 3.** Open the Printer Door by pressing the Door Release button on the top of the Printer.
- Step 4.** Locate the area where the Card Cleaning Roller will be installed; circled below.

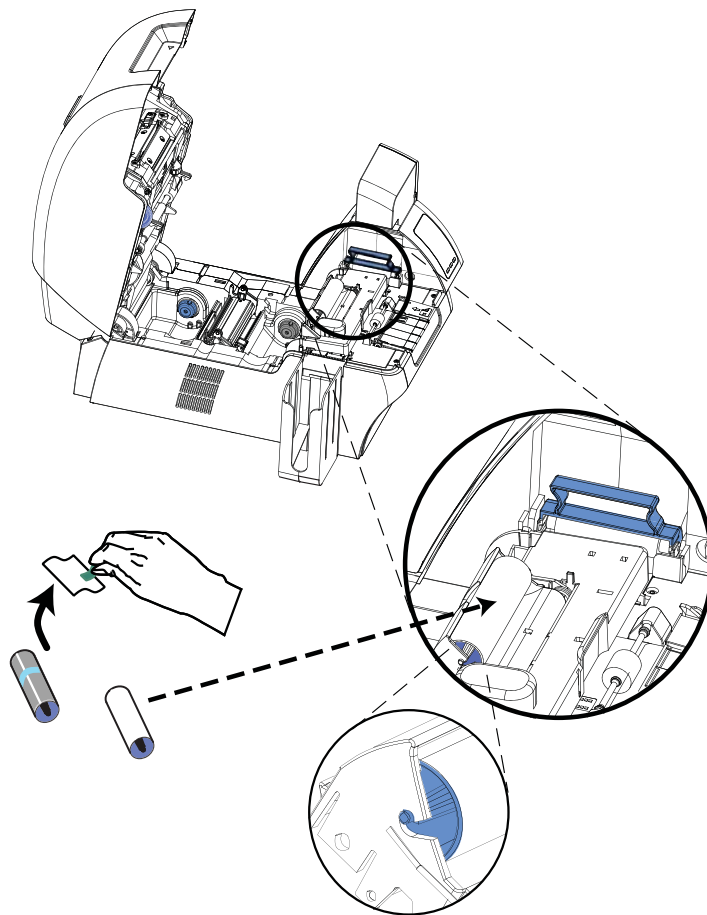

- Step 5.** Hold the Card Cleaning Roller by the ends.
- Step 6.** Position the ends of the Card Cleaning Roller in the slots.
- Step 7.** Push until the roller fully seats and latches.
- Step 8.** Close the Printer's Door.

## Loading the Transfer Film

The ZXP Series 8 printer is designed to work only with Zebra True Colours™ i Series™ Transfer Film for near photographic print resolution and over-the-edge printing.

**Step 1.** Locate the transfer film supply spindles and the transfer film take-up spindles. Note that the Flanges and Spindles are color coded (white-to-white, green-to-green).

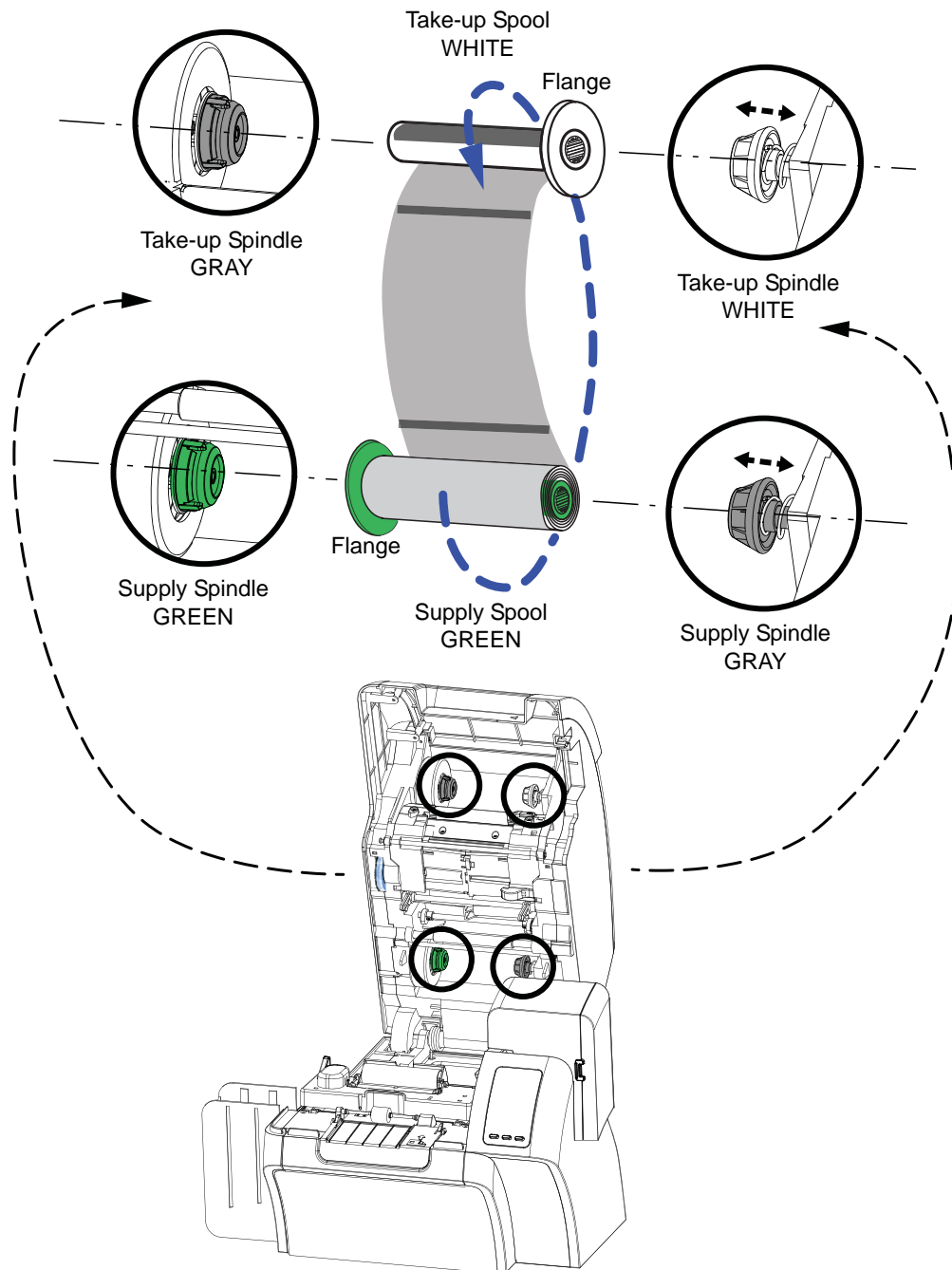

## Installation and Setup

### Loading the Transfer Film

- Step 2.** Unroll about one foot from the full roll of transfer film (supply spool), and wind it (2 wraps) onto the empty take-up spool.
- Step 3.** Load transfer film supply spool onto the supply spindles, **green flange side to the left.**
- Step 4.** Load the empty take-up spool onto the take-up spindles, **white flange side to the right.**
- Step 5.** Make sure the transfer film comes off the bottom of the supply spool and feeds to the bottom of the take-up spool.
- Step 6.** The figure below shows the proper installation of the transfer film.

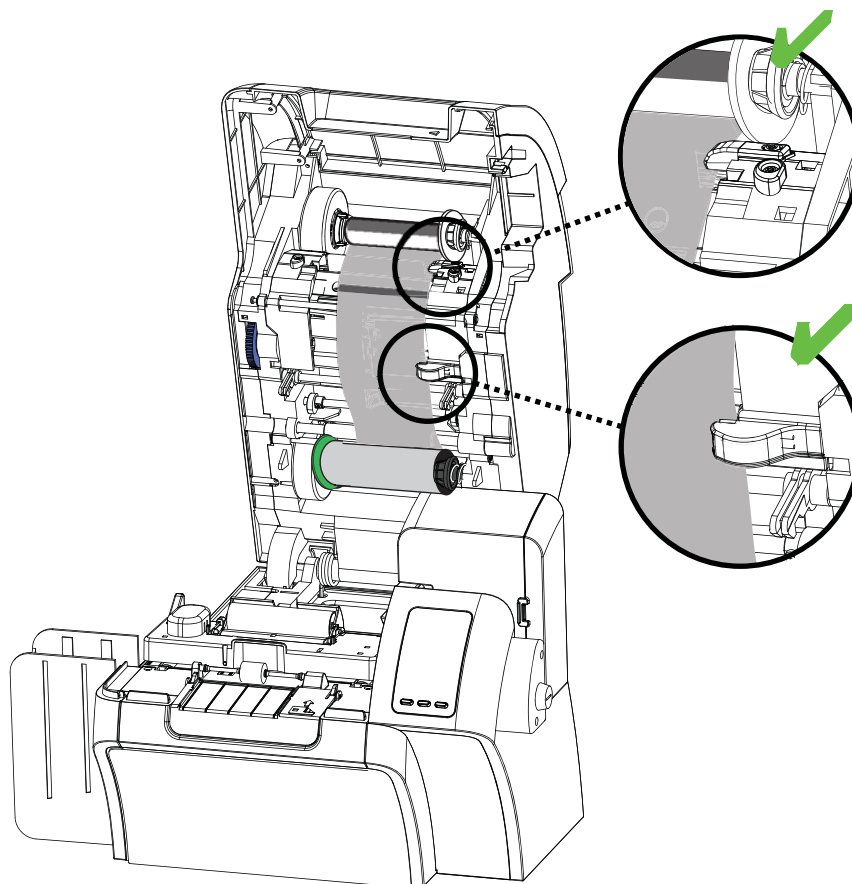

# Loading a Print Ribbon

The ZXP Series 8 printer is designed to work only with Zebra True Colours® i Series™ Ribbons in order to achieve rich, vibrant, image production over the full-color spectrum.

**Step 1.** Locate the print ribbon supply spindles and the print ribbon take-up spindles. Note that the Flanges and Spindles are color coded (blue-to-blue, purple-to-purple).

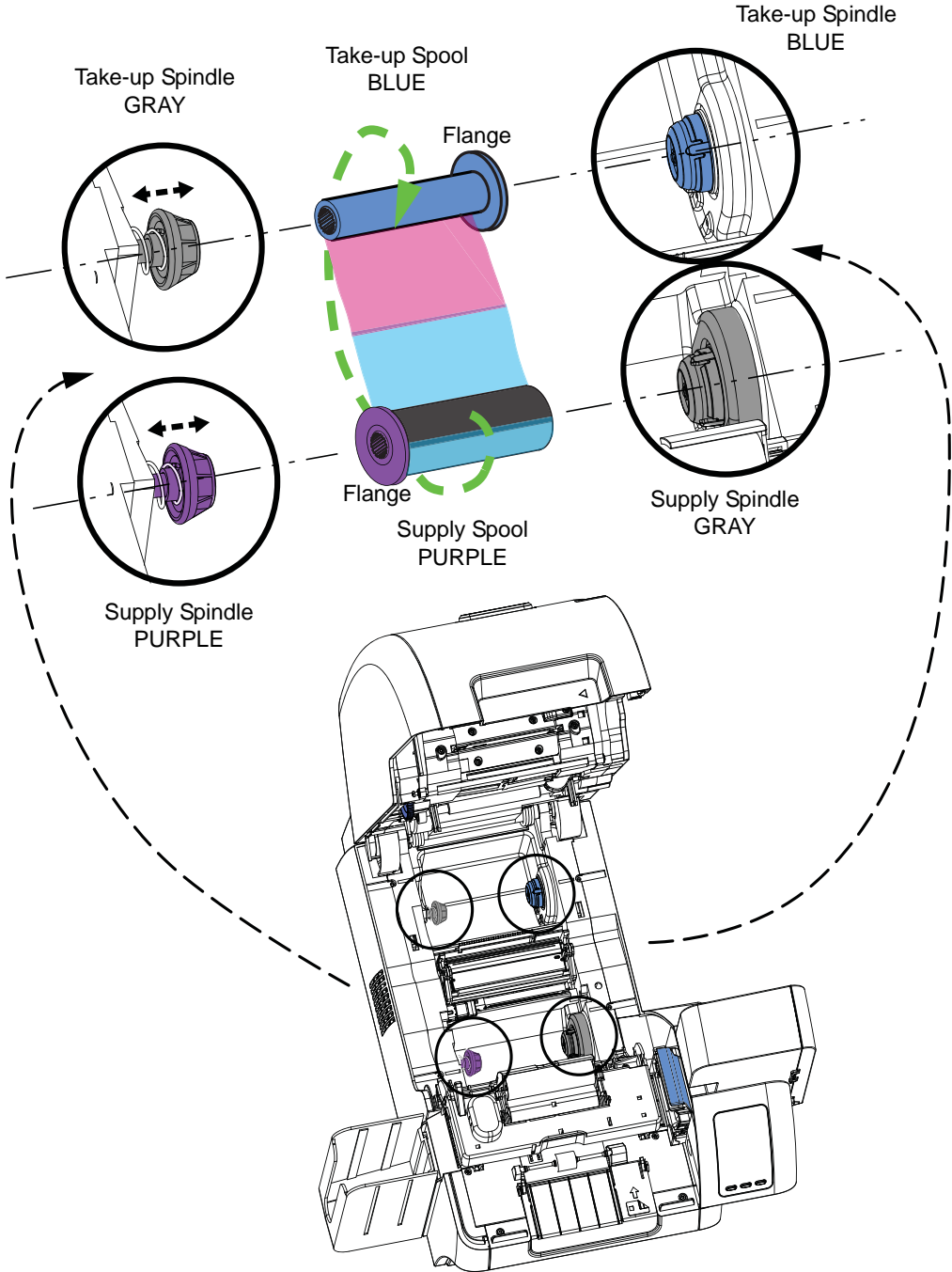

## Installation and Setup

### Loading a Print Ribbon

- Step 2.** Load the print ribbon supply spool onto the supply spindles, **purple flange side to the left**.
- Step 3.** Load the empty take-up spool onto the take-up spindle, **blue flange side to the right**.
- Step 4.** Make sure the print ribbon comes off the bottom of the supply spool and feeds to the bottom of the take-up spool.
- Step 5.** The figure below shows the proper installation of the print ribbon.

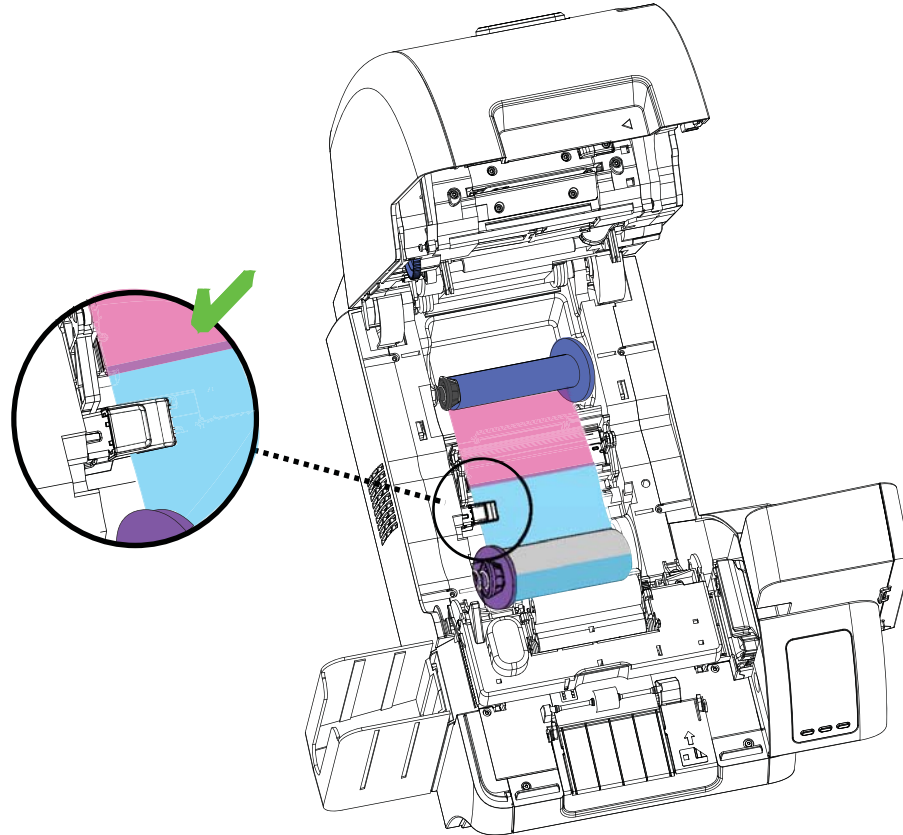

## Connecting Power



**Electric Shock Caution** • Limit AC power supplied to the Printer to 100 – 230 volts, 60 ~ 50 Hertz. Limit excess current draw to 16 amps or less, using an associated circuit breaker or other such device. Never operate the Printer in a location where operator, computer, or printer can get wet. Personal injury could result. The Printer must be connected to an earthed electrical power source and properly protected against electrical surges and grounding faults; the electrical reliability of the Printer is based on the reliability of the mains power source and with the earth connection.

The Printer's power supply is an internal unit that can only be serviced or replaced by trained and authorized personnel.

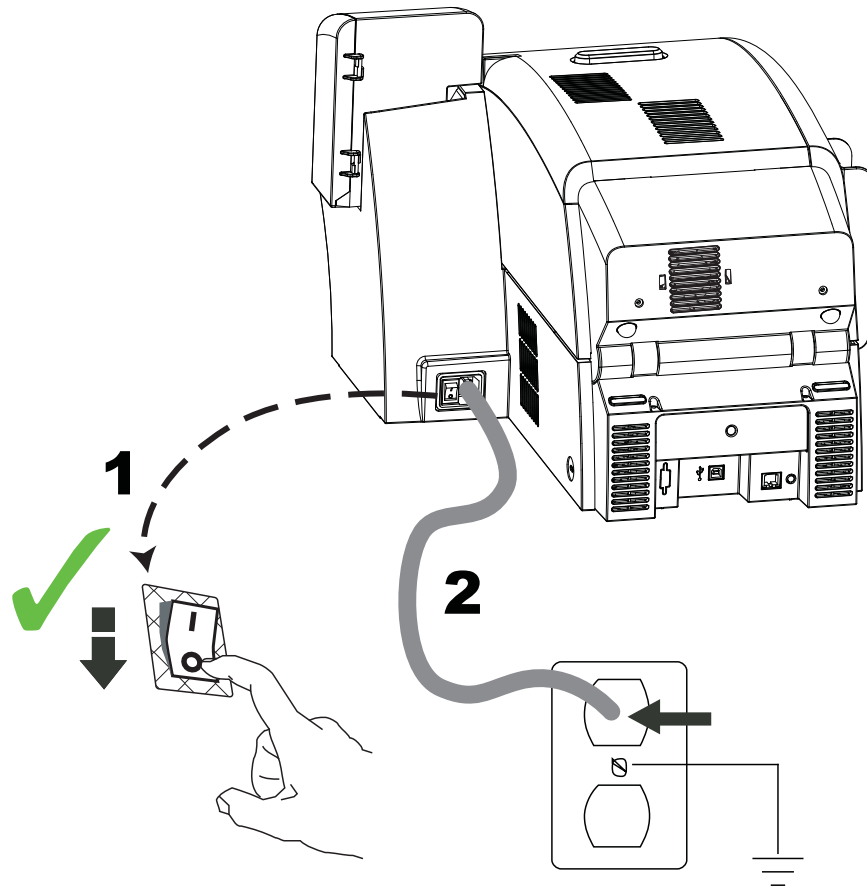

- Step 1.** Place the Printer's power switch in the OFF (○) position.
- Step 2.** Depending on your local AC voltage, plug the appropriate power cord into the Printer's power connector and a grounded AC power source connection.

**DO NOT SWITCH THE PRINTER ON.**

## Connecting the Printer to your Computer

### USB Connection

- Step 1.** Connect the USB cable to the printer and the computer.
- Step 2.** Ensure that the printer's power switch in the OFF (○) position.

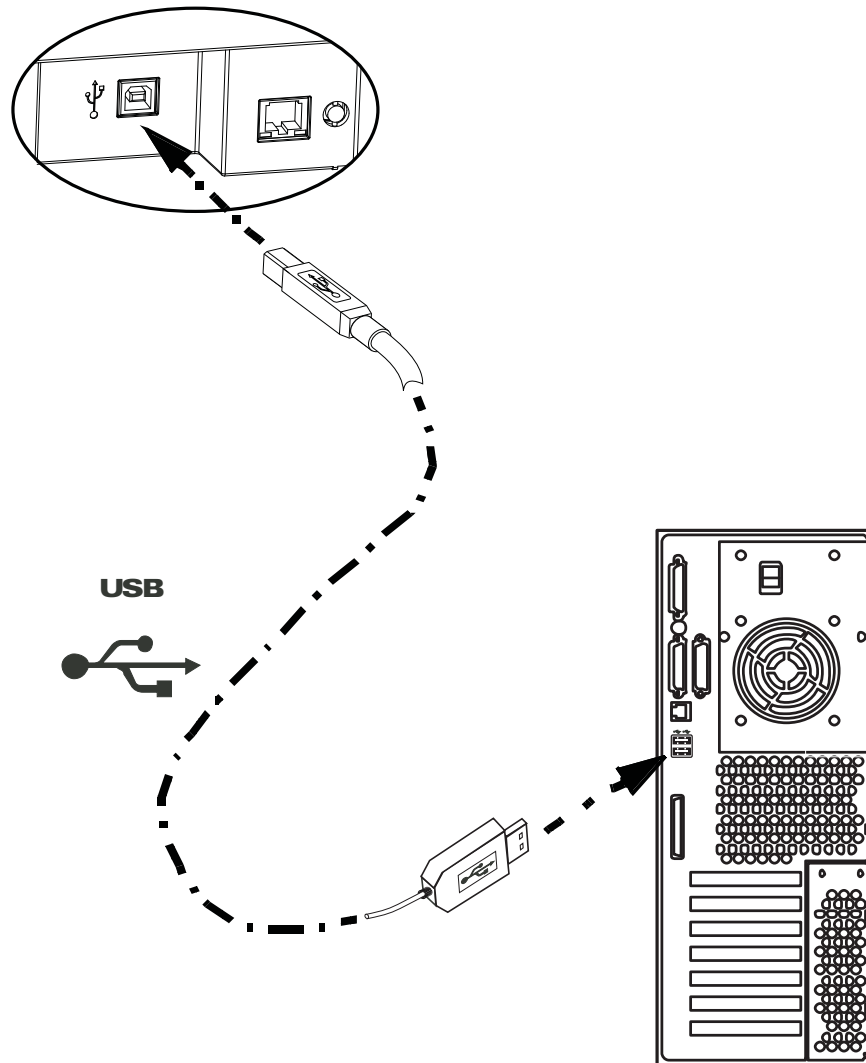



## Ethernet Connection

**Step 1.** Connect the Ethernet Port on the rear of the printer to an Ethernet Network Port.

**Step 2.** Turn the printer's power switch to the ON ( | ) position.

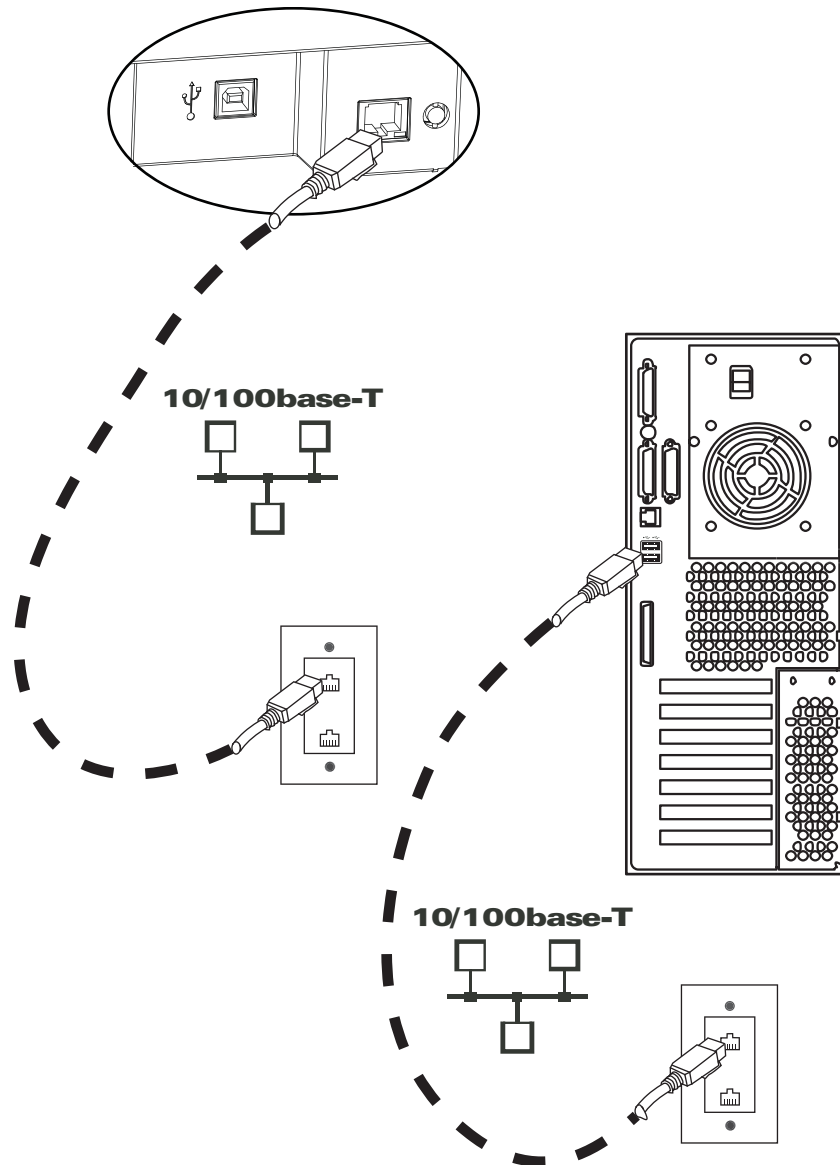

# Installing the Windows Printer Driver

## Initial Steps

Each computer that will use the printer must have the Printer Driver installed.

If not already done, connect power to the printer; and connect the printer to the computer.

- For USB Driver installation, turn the printer OFF (  ).
- For Ethernet Driver installation, turn the printer ON (  ).

To install the Printer Driver, insert the **User Documentation and Drivers CD**, included with your printer, into the host computer and the InstallShield Wizard will walk you through the required installation steps. The InstallShield Wizard will:

- Automatically install the User Interface when the driver CD is inserted. (Autorun must be enabled for your CD).

If Autorun is disabled:

- a. Insert the Driver CD into the CD-ROM drive.
  - b. At the root (top) level of the CD, double-click on the RunCD.exe file.
- Start the installation process when the **Install Printer Driver** menu item is selected from the Main Menu.

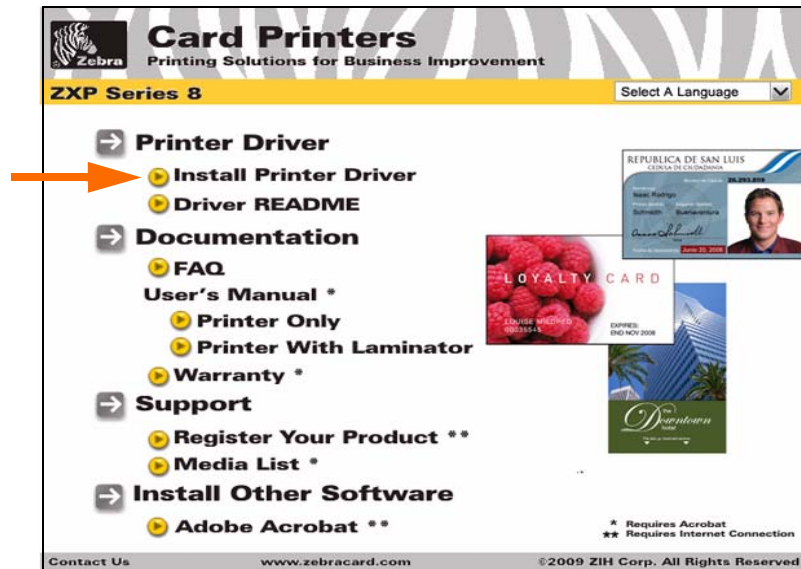

- Detect previous versions of the driver. If a previous version is detected, you will be prompted to remove it, reboot, and then restart the install process.
- Install the new driver files; see USB (on [Page 23](#)) and/or Ethernet (on [Page 28](#) ).

## Installing the USB Printer Driver



**Note** • To install the Ethernet driver, see [Page 28](#).

- Step 1.** If not already done, connect power to the printer. Do not turn power ON.
- Step 2.** Connect the USB port on the rear of the printer to the computer's USB port.
- Step 3.** Ensure that the Printer's power switch is in the OFF (  ) position.
- Step 4.** Insert the **User Documentation and Drivers CD** into the CD drive of the host computer. The **Main Menu** will open.
- Step 5.** From the drop-down menu in the upper-right corner of the **Main Menu**, choose the appropriate language for your system.
- Step 6.** From the **Main Menu**, click **Install Printer Driver**.
- Step 7.** If an older Printer and Driver is installed on your computer, the **Welcome** window will be displayed; otherwise go to [Step 9](#).

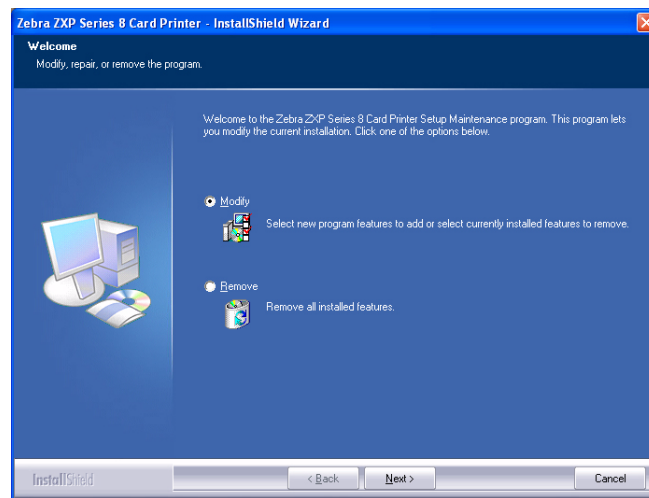

- Step 8.** In the **Welcome** window, choose the maintenance operation to be performed:
  - a.** Select **Modify** to upgrade the older printer driver, click the **Next** button, and follow the screen prompts. At the end of the upgrade process, you will be asked to re-boot your computer. Re-boot your computer. The upgrade is complete.
  - b.** Select **Remove** to remove the older printer driver, click the **Next** button, and follow the screen prompts. At the end of the uninstall process, you will be asked to re-boot your computer. Re-boot your computer, and start over with [Step 1](#).

## Installation and Setup

### Installing the Windows Printer Driver

**Step 9.** The **InstallShield Wizard** window will open. To proceed with the installation, click the **Next** button.

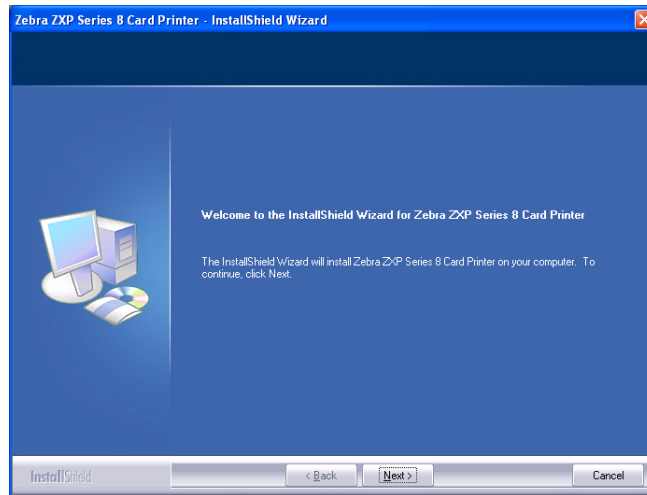

**Step 10.** Select **Install USB printer drivers**, and click the **Next** button.

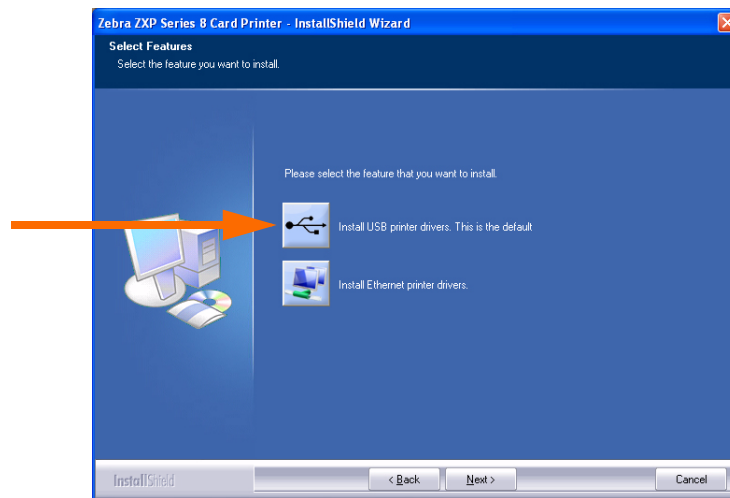

**Step 11.** Ensure that the Printer's power switch in the OFF (○) position; and then click the **OK** button.

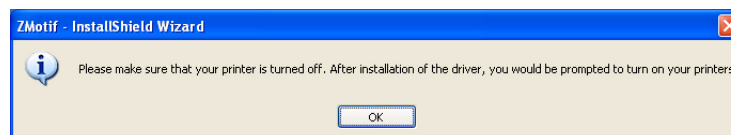

**Step 12.** This will bring up the **License Agreement** window. To proceed with the installation, select the *I accept the terms of the license agreement* option, and then click the **Next** button.

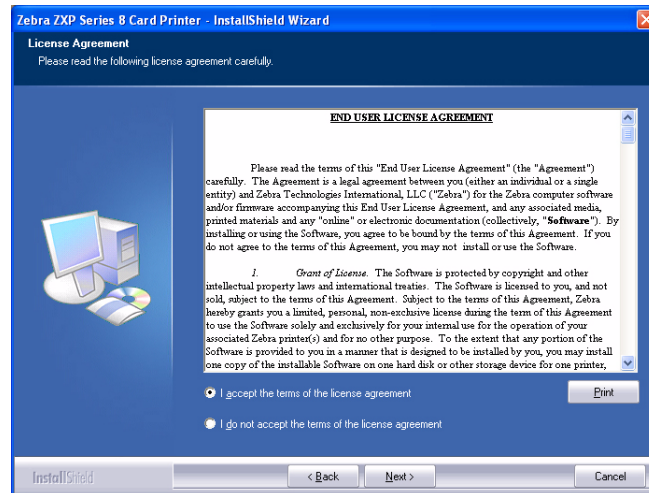

**Step 13.** This will bring up the **Customer Information** window. Enter User Name and Company Name; and then click the **Next** button.

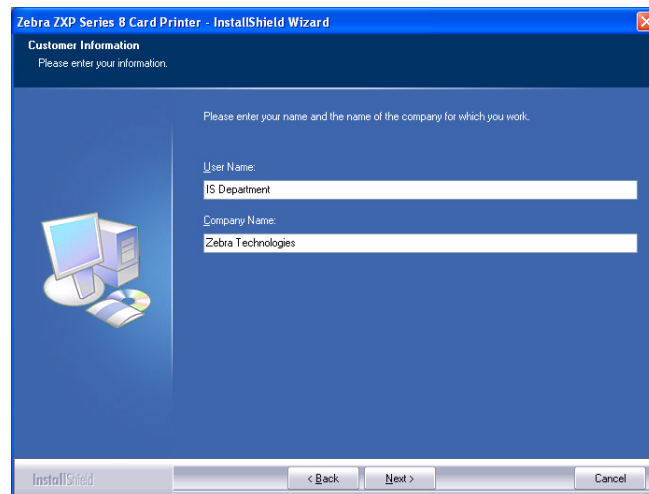

## Installation and Setup

### Installing the Windows Printer Driver

**Step 14.** This will bring up the **Choose Destination Location** window.

- To accept the default destination location where setup will install the files, click the **Next** button.
- or -
- Select a folder where setup will install the files, and click the **Next** button.

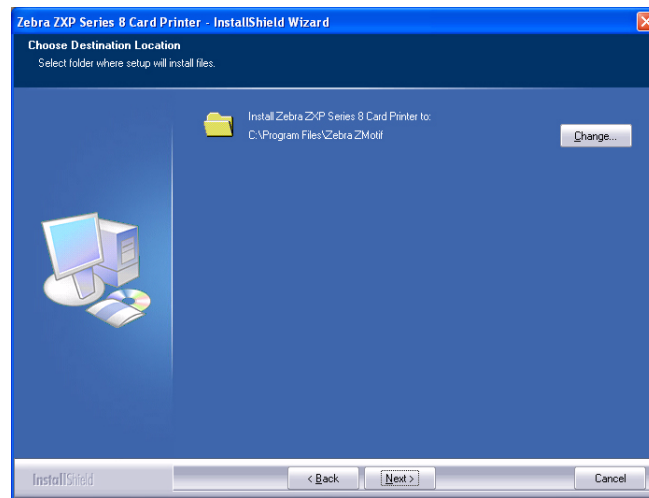

**Step 15.** This will bring up the **Ready to Install the Program** window. To continue, click the **Install** button.

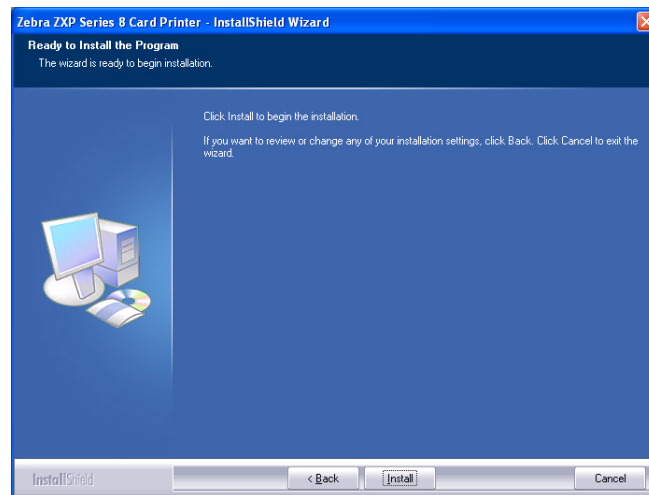

**Step 16.** Observe the **Setup Status** window.

**Step 17.** The **Congratulations** window will appear.

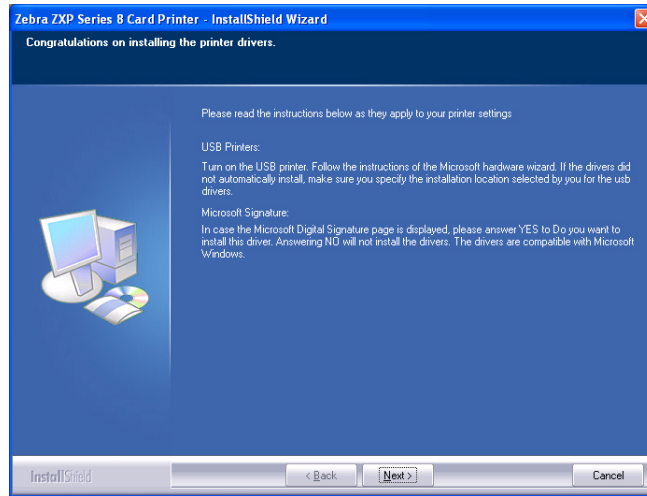

**Step 18.** At this point, **turn on your printer**; and then click the **Next** button. The *Windows New Hardware Found* wizard will find the printer.

**Step 19.** When the **InstallShield Wizard Complete** window appears, select the *Yes, I want to restart my computer now* radio button; and click the **Finish** button.

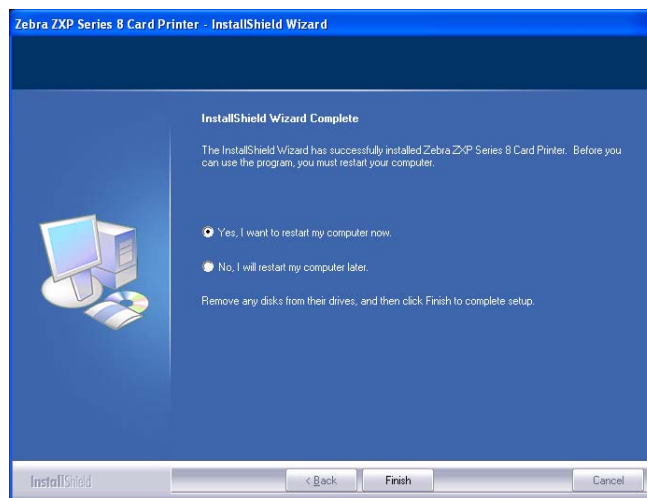

**Step 20.** This completes USB driver installation.

**Step 21.** To use the Printer, you would select it just like you would any other printer connected to a Windows system.

Note that you may need to change the card setup (card type, orientation, etc.), encoding, and/or black panel settings via the Printer Driver; see *Printing Preferences* on page 60.

## Installing the Ethernet Printer Driver



**Note** • To install the USB driver, see [Page 23](#).



**Important** • The Ethernet Network must be configured correctly, with the Printer and the host computer on the same subnet mask. Use the printer's default-configured DHCP address (there must be a DHCP server on the network) or set the Printer to a Static IP address; see [Network Settings Menu](#) on page 46. If you are not sure how to verify this or change the configuration, consult someone knowledgeable on Ethernet Networks.

- Step 1.** If not already done, connect power to the printer. Turn power ON.
- Step 2.** Connect the Ethernet port on the rear of the printer to the Ethernet network connection or directly to the computer's Ethernet port.
- Step 3.** Ensure that the Printer's power switch in the ON ( | ) position.
- Step 4.** Insert the **User Documentation and Drivers CD** into the CD drive of the host computer. The **Main Menu** will open.
- Step 5.** From the drop-down menu in the upper-right corner of the **Main Menu**, choose the appropriate language for your system.
- Step 6.** From the **Main Menu**, click **Install Printer Driver**.
- Step 7.** If an older Printer and Driver is installed on your computer, the **Welcome** window will be displayed; otherwise go to [Step 9](#).

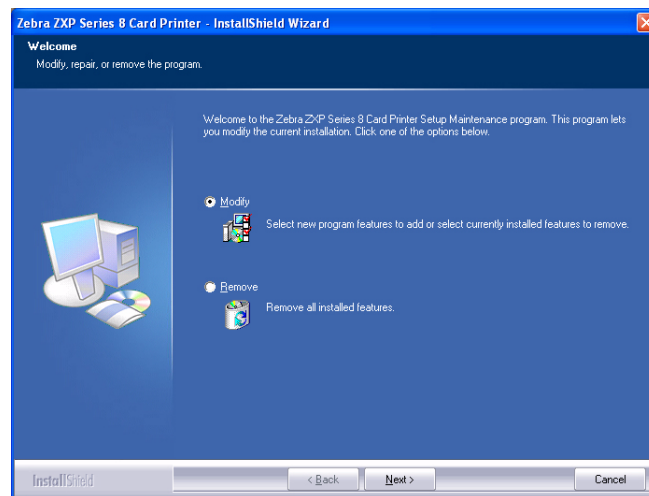



- Step 8.** In the **Welcome** window, choose the maintenance operation to be performed:
- a.** Select **Modify** to upgrade the older printer driver, click the **Next** button, and follow the screen prompts. At the end of the upgrade process, you will be asked to re-boot your computer. Re-boot your computer. The upgrade is complete.
  - b.** Select **Remove** to remove the older printer driver, click the **Next** button, and follow the screen prompts. At the end of the uninstall process, you will be asked to re-boot your computer. Re-boot your computer, and start over with [Step 1](#).
- Step 9.** The **InstallShield Wizard** window will open. To proceed with the installation, click the **Next** button.

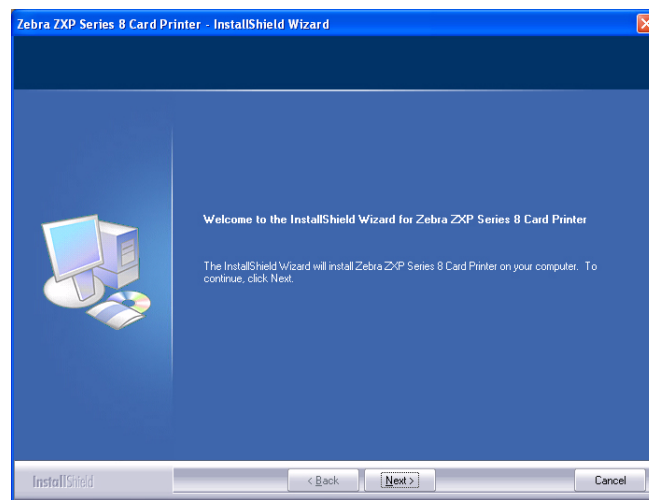

- Step 10.** Select **Install Ethernet printer drivers**, and click the **Next** button.

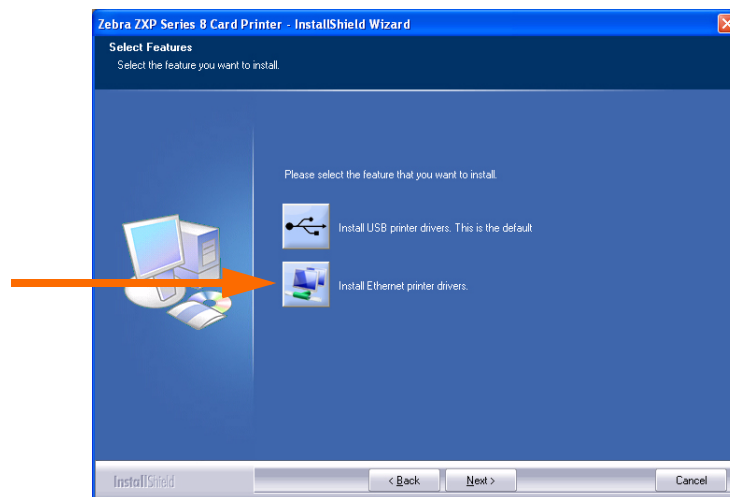

## Installation and Setup

### Installing the Windows Printer Driver

**Step 11.** Ensure that you have powered ON ( | ) the network printer and it is reachable from the PC; and then click the **OK** button.



**Step 12.** This will bring up the **License Agreement** window. To proceed with the installation, select the *I accept the terms of the license agreement* option, and then click the **Next** button.

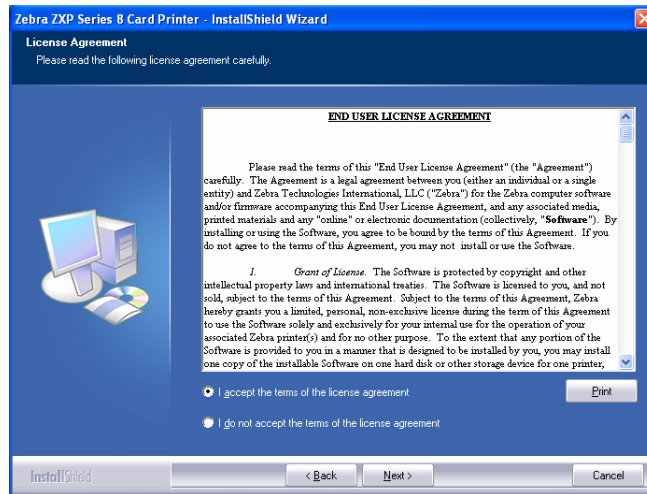

**Step 13.** This will bring up the **Customer Information** window. Enter your name and the name of the company for which you work; and then click the **Next** button.

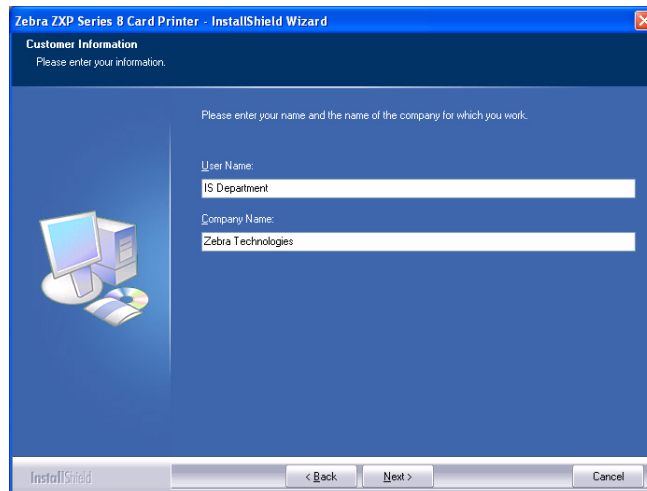

**Step 14.** Identify the printer:

- Click on the **Search** button (arrow below) to search for all the Ethernet printers on the network, select the desired printer, and then click the **Next** button.

- or -

- Enter the Printer IP Address directly (example circled below), and click the **Next** button.

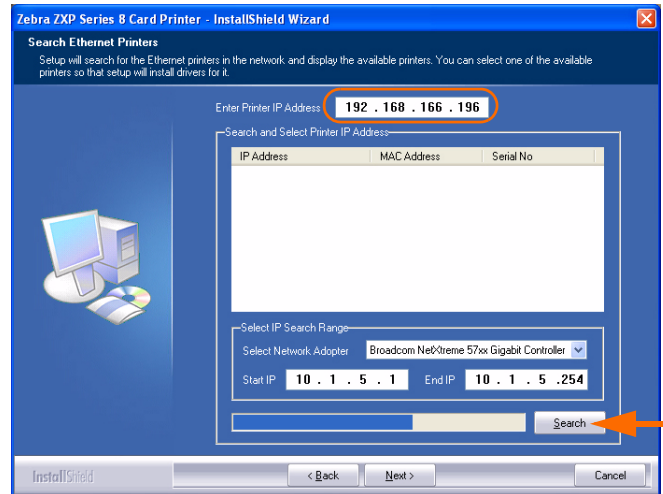

**Step 15.** Enter the location of the printer, and add any applicable comments; and then click the **Next** button.

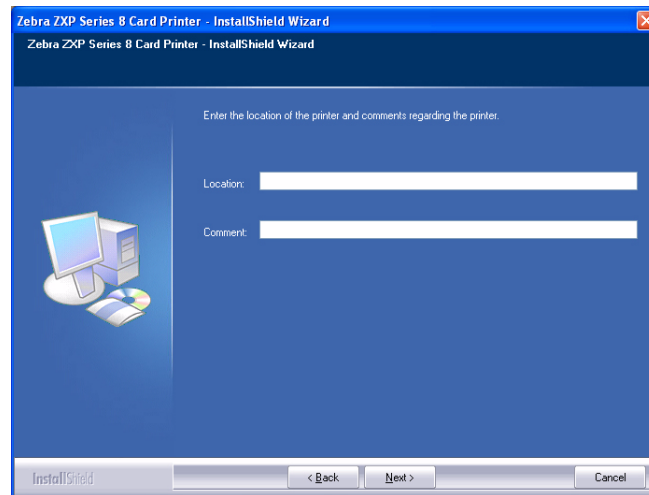

## Installation and Setup

### Installing the Windows Printer Driver

**Step 16.** This will bring up the **Choose Destination Location** window.

- To accept the default destination location where setup will install the files, click the **Next** button.
- or -
- Click the **Change** button, select a folder where setup will install the files, and click the **Next** button.

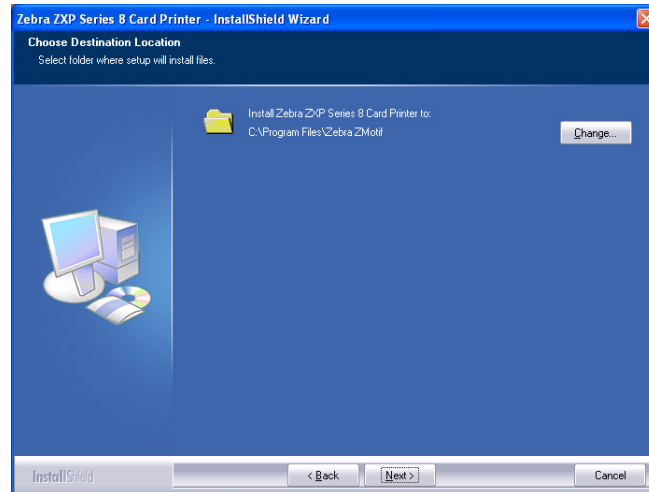

**Step 17.** This will bring up the **Ready to Install the Program** window. To continue, click the **Install** button.

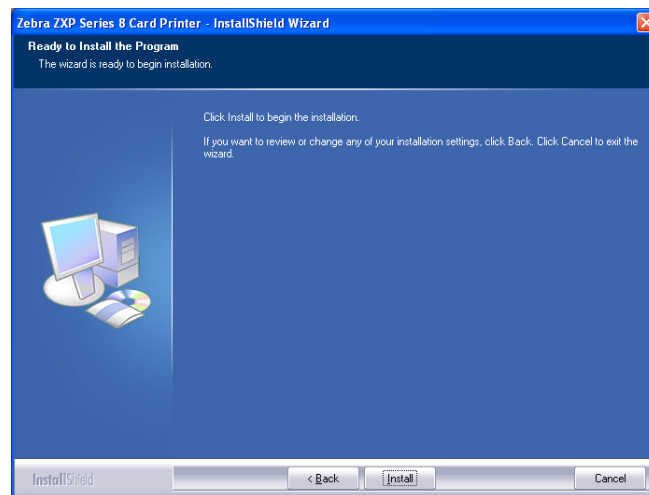

**Step 18.** Observe the **Setup Status** window.

**Step 19.** When the **InstallShield Wizard Complete** window appears, click the **Finish** button.

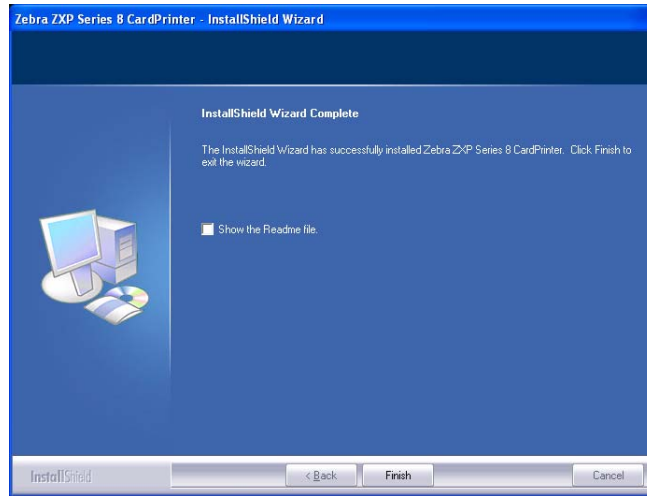

**Step 20.** This completes Ethernet driver installation.

**Step 21.** To use the Printer, you would select it just like you would any other printer connected to the Ethernet.



**Note •** You may need to change the card setup (card type, orientation, etc.), encoding, and/or black panel settings via the Printer Driver; see [Printing Preferences](#) on page 60.

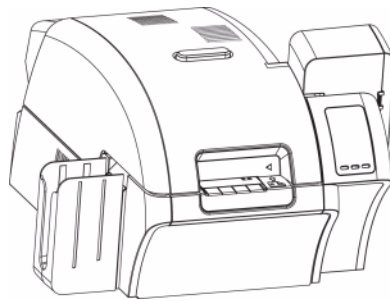



---

# Operation

## Introduction

Printing with the Card Printer is similar to printing with any other printer in a Windows environment.

- The Printer Driver Software is installed on your computer (see [Section 2](#)).
- The Printer is connected to the power source and the computer (see [Section 2](#)).
- The Printer is selected by either the Operating System or the appropriate application software program.
- Printer Properties are set (the factory default values will be appropriate for many applications).
- Set the Card Type.
- Print a Test Card.
- Card printing is directed by the appropriate application software program.

## Card Type Selection

The **Card Setup** tab allows you to specify the card type in use. Based on your selection, the printer automatically adjusts various printer properties for optimum print quality.

To access the Card Setup Tab, select *Start > Printers and Faxes*. Right click on the *Zebra ZXP Series 8 Card Printer* listing; and select *Printing Preferences > Card Setup*.



**Important** • If your card type is not listed in the drop-down menu, select *Custom*; and fill out the Card Specifications pop-up screen; see [Appendix B](#) for details.

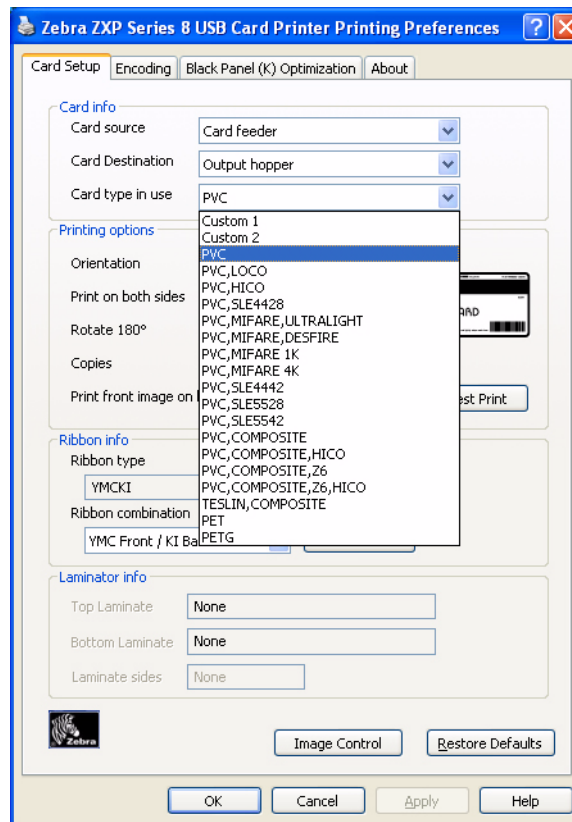

- Make the appropriate Card Type selection. Note that *PVC* is the default.



## Printing a Sample Card

Sample card designs are installed with the printer driver. To print a sample card:

1. Access the Card Setup Tab, select *Start > Printers and Faxes*. Right click on the *Zebra ZXP Series 8 Card Printer* listing; and select *Printing Preferences > Card Setup*.

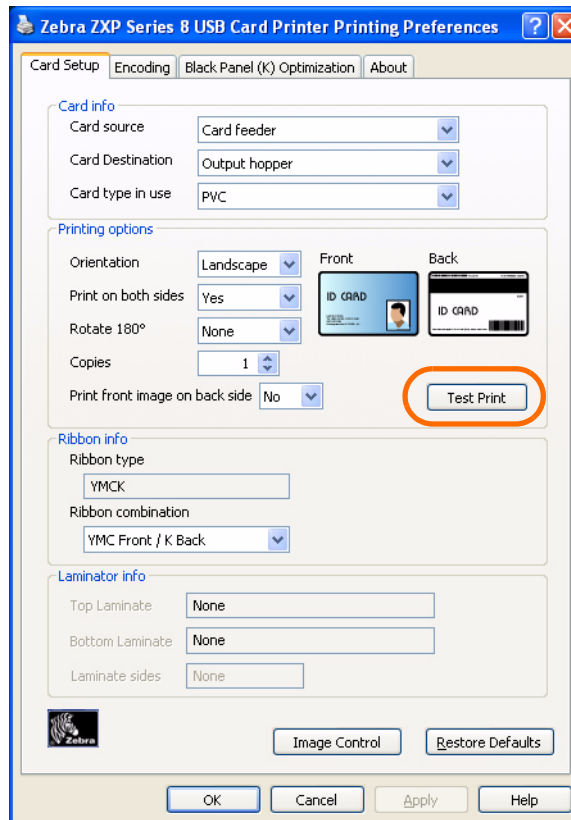

2. Ensure that cards are in the Input Hopper.
3. Click of the **Test Print** button (circled above).



**Note** • It is normal for the Printer to warm up to operating temperature before printing.

4. The printer will feed in a card and start printing.
5. Once the printing job is complete, the card is ejected from the printer into the Output Hopper.

## Manual Card Feed

A Manual Feed Slot is available for feeding single cards. The Input Hopper must be empty for single-card feeding to work properly.

1. Access the Card Setup Tab: Select *Start > Printers and Faxes*. Right click on the *Zebra ZXP Series 8 Card Printer* listing; and select *Printing Preferences > Card Setup*.

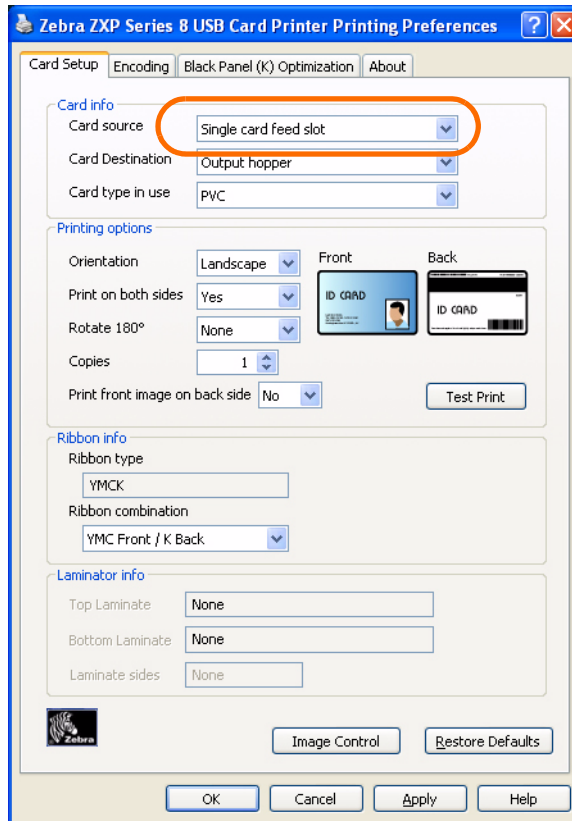

2. From the Card Info > Card source dropdown menu, select the *Single card feed slot* (circled above).
3. Click on the **Apply** button, and then click on the **OK** button.
4. Ensure that there are no cards in the Input Hopper.

5. Insert a single card into the slot in the correct orientation. Do not feed more than one card at a time.



**Caution** • DO NOT bend cards or touch print surfaces as this can reduce print quality. The surface of the cards must remain clean and dust free. Always store cards in an enclosed container. Ideally, use cards as soon as possible.

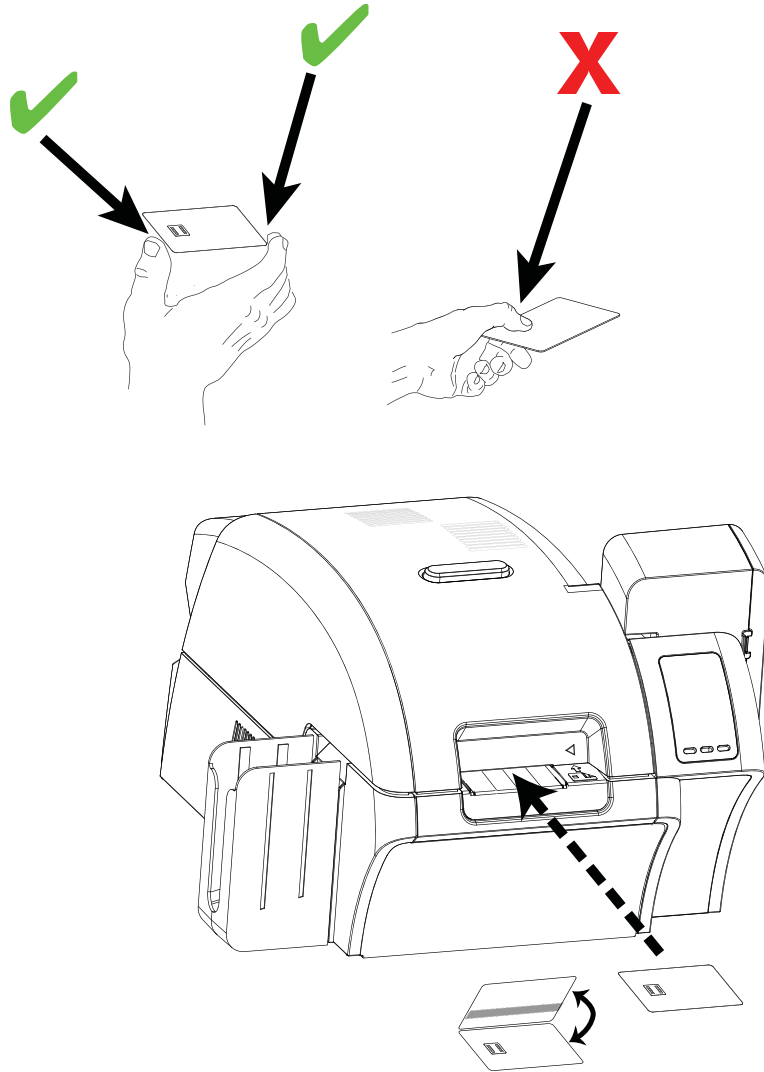

## Operator Control Panel (OCP)

The printer is equipped with an OCP Display and three OCP Buttons which give access to the printer menus. The menus can be accessed when the printer status shows READY.



- Press the **MENU** button, to access the Main Menu.
- Press the **INFO** button, to access and view the Printer Settings Menu.
- Press the **CANCEL** button, to cancel the current print job in the printer.

## Messages

Your printer is equipped with an OCP Display to provide printer status information. The readout is controlled by three OCP Buttons directly below the OCP Display. The messages displayed fall into three categories:

- Operational, see [page 41](#).
- Warning, see [page 42](#).
- Error, see [page 42](#).

## Operational Messages

MESSAGE	DESCRIPTION
ALARM	An error message needs to be cleared before normal operations can resume.
CANCELING	The Cancel button was pressed, and the current operation is being terminated.
CONFIG DATA	Configuration data is being transferred from the computer to the printer.
CONTACT OPERATION	Contact Smart Card is being encoded; i.e., the card is in position and data is being transferred.
CONTACTLESS OPERATION	Contactless Smart Card is being encoded; i.e., the card is in position and data is being transferred.
COOLING	Ready to accept a print job, rollers cooling; e.g., when switching from 2-sided printing to 1-sided printing.
COOLING PRINT JOB WAITING	Print job received, cooling rollers to temperature.
COOLING PRINthead TEMPERATURE	Cooling printhead to temperature.
COOLING WAITING TO LAMINATE *	Ready to accept a print job, laminator cooling; e.g., when switching from 2-sided to 1-sided laminating.
DIAGNOSTIC	Diagnostic testing in progress.
JOB DATA	Data is being transferred from the computer to the printer.
LAMINATING *	Print job received, laminating in process.
MAG OPERATION	A Magnetic Stripe Card is being encoded; i.e., card is in position and data is being transferred.
MANUALLY INSERT CARD FROM FRONT	Waiting for manual card feed (this function is set via the <a href="#">Card Setup Tab</a> on page 61).
OFFLINE	Status toggled (offline/online) via the OCP Advanced Settings Menu.
PRINTING	Print job received, printing in process.
READY	Ready and at temperature.
STANDBY	Printer is in "sleep" mode; i.e., power save mode.
WAIT INITIALIZING	Performing a self test on startup.
WARMING	Ready to accept a print job, rollers heating; e.g., at startup or when switching from 1-sided printing to 2-sided printing.
WARMING PRINT JOB WAITING	Print job received, warming rollers to temperature.
WARMING WAITING TO LAMINATE *	Ready to accept a print job, laminator warming; e.g., when switching from 1-sided to 2-sided laminating.
WARMING PRINthead TEMPERATURE	Warming printhead to temperature.
WARNING	Indicates that additional OCP instructions need to be performed; e.g., PRINT RIBBON LOW, etc.

\* Message only applies to Printers with a Laminator.

## Warning Messages

Warnings alert the operator to action that should be taken; the printer will generally continue operation.

<b>WARNING (Printer will still operate)</b>	<b>DESCRIPTION</b>
BOTTOM LAMINATE LOW *	Indicates that the Bottom Laminate cassette is low.
CLEAN FRONT CARD PATH	Indicates that the Front Card Path (Y-Drive Rollers) needs cleaning; see <a href="#">Cleaning the Printer, Section 6</a> .
CLEAN LAMINATOR *	Indicates that the Laminator Path needs cleaning.
CLEAN LAM ROLLERS *	Indicates that the Laminator Media Feed Rollers need cleaning.
CLEAN LAM OVEN *	Indicates that the Laminator Transfer Path (Heated Rollers) needs cleaning.
CLEAN SIDE CARD PATH	Indicates that the Side Card Path (X-Drive Rollers) needs cleaning; see <a href="#">Cleaning the Printer, Section 6</a> .
CLEAN TRANSFER PATH	Indicates that the Transfer Path (Heated Rollers) needs cleaning; see <a href="#">Cleaning the Printer, Section 6</a> .
PRINT RIBBON LOW	Indicates that the Print Ribbon spool is low; see <a href="#">Loading a Print Ribbon, Section 2</a> .
TOP LAMINATE LOW *	Indicates that the Top Laminate cassette is low.
TRANSFER FILM LOW	Indicates that the Transfer Film spool is low; see <a href="#">Loading the Transfer Film, Section 2</a> .

NOTE: Message only applies to Printers with a Laminator.

## Error Messages

Errors are displayed when a situation causes the printer to stop operating. Depending on the cause of the error message, restarting the printer or clearing the displayed error may return the printer to operational status; or the printer may require troubleshooting and repair.

Refer to [Section 7, Troubleshooting](#), for a list of the error messages, possible causes, and possible solutions.

# Printer Menu Information

## Info Menu

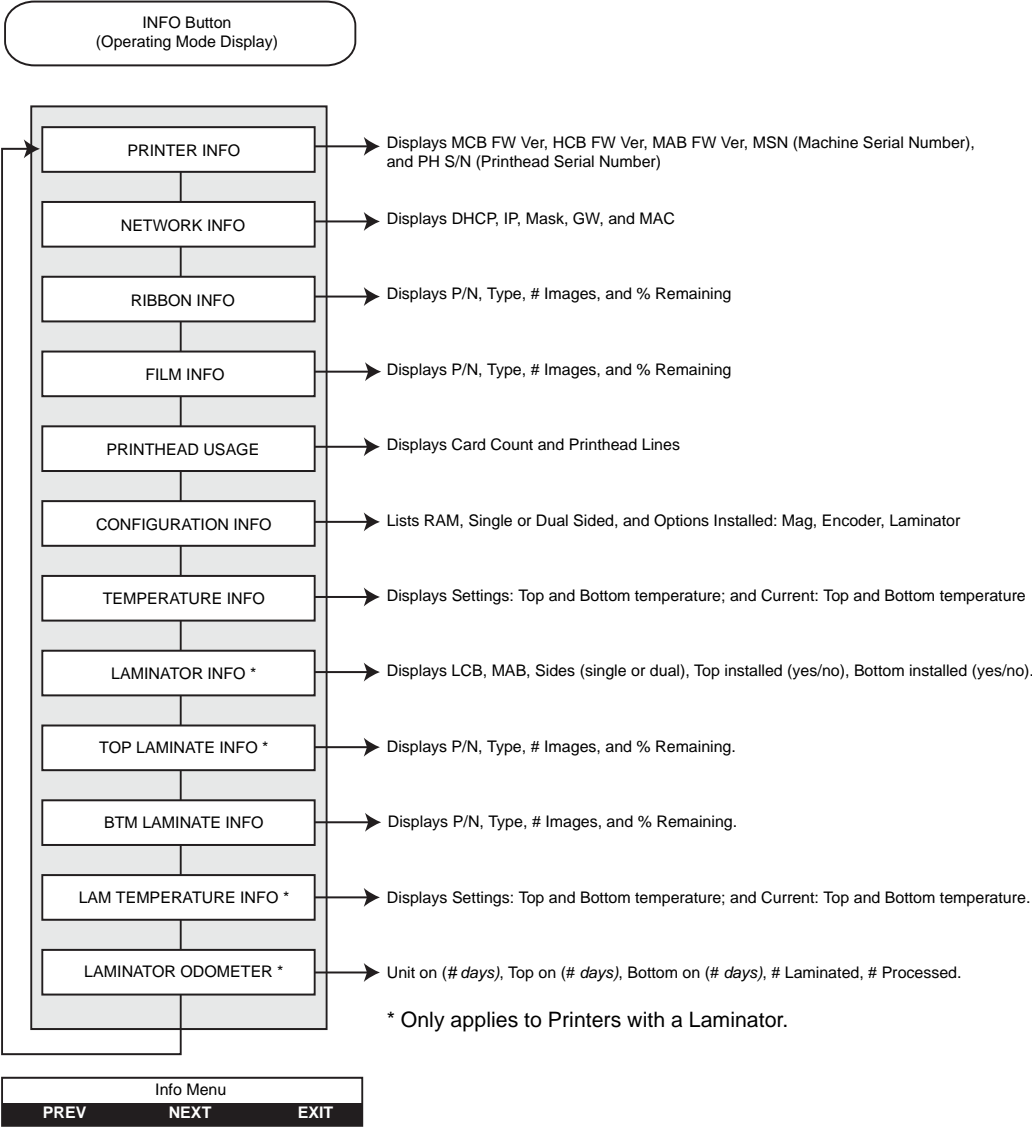

- Press the **PREV** button to move up the menu list
- Press the **NEXT** button to move down the menu list
- Press the **EXIT** button to return to the Operating Mode Display

## Main Menu

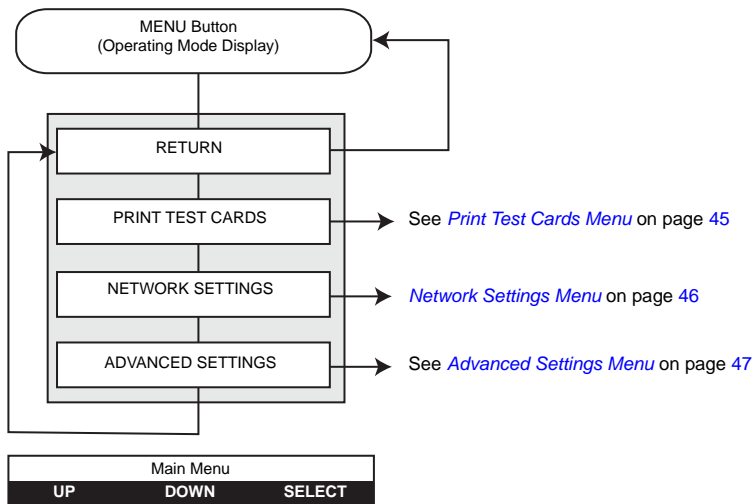

- Press the **UP** button to move up the menu list
- Press the **DOWN** button to move down the menu list
- Press the **SELECT** button to select the item from the list.



### Print Test Cards Menu

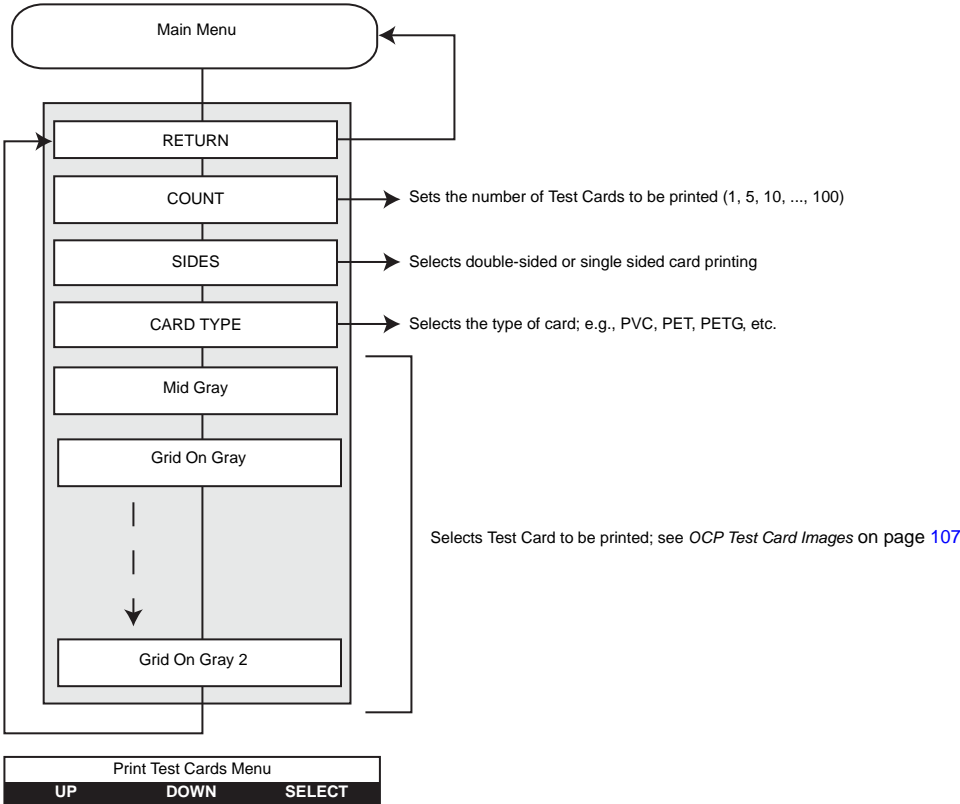

- Press the **UP** button to move up the menu list
- Press the **DOWN** button to move down the menu list
- Press the **SELECT** button to select the item from the list.

## Network Settings Menu

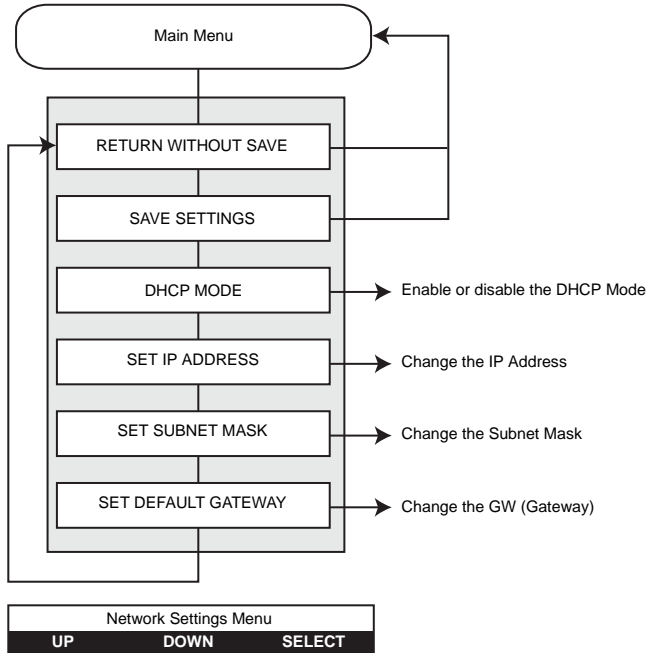

- Press the **UP** button to move up the menu list
- Press the **DOWN** button to move down the menu list
- Press the **SELECT** button to select the item from the list.

## Advanced Settings Menu

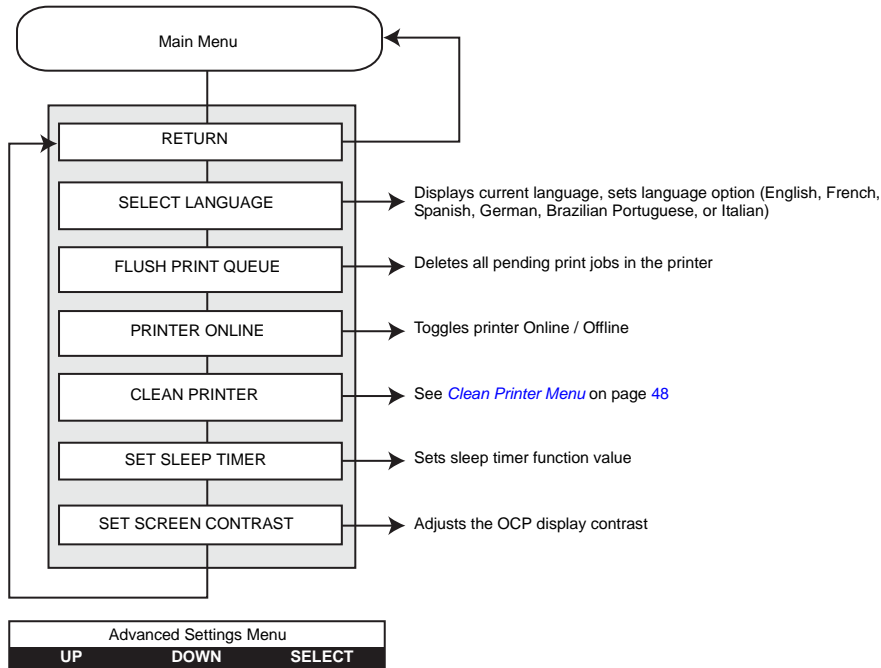

- Press the **UP** button to move up the menu list
- Press the **DOWN** button to move down the menu list
- Press the **SELECT** button to select the item from the list.

## Clean Printer Menu

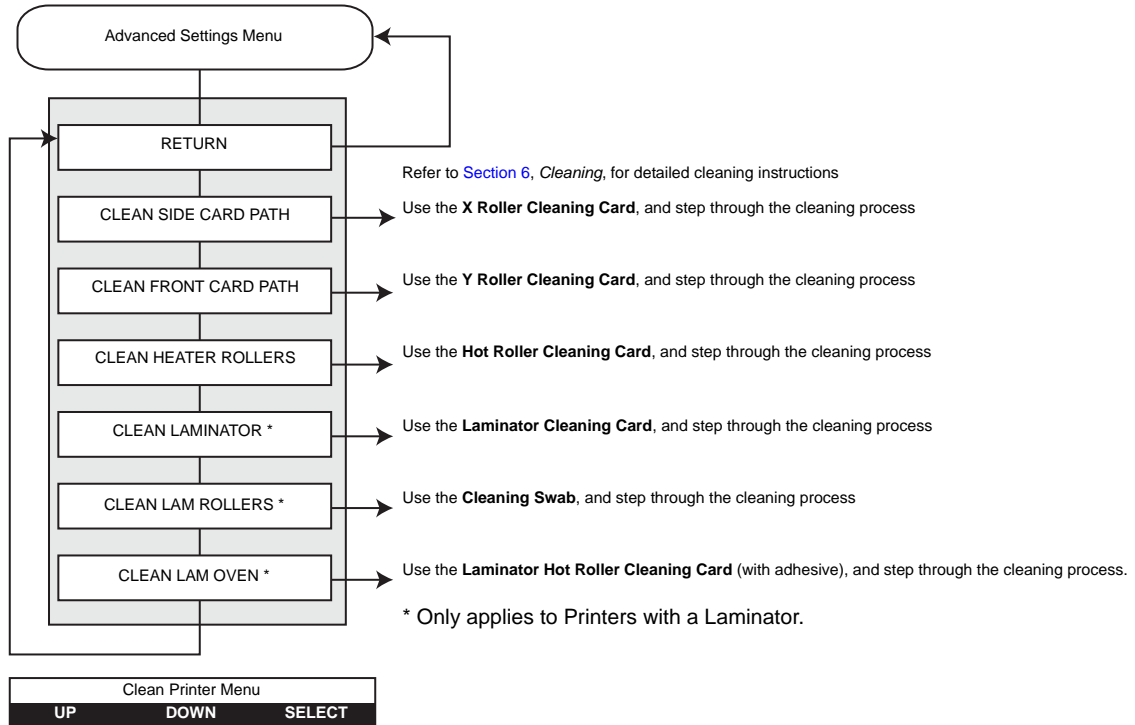

- Press the **UP** button to move up the menu list
- Press the **DOWN** button to move down the menu list
- Press the **SELECT** button to select the item from the list.

## Ethernet Indicators -- Detail

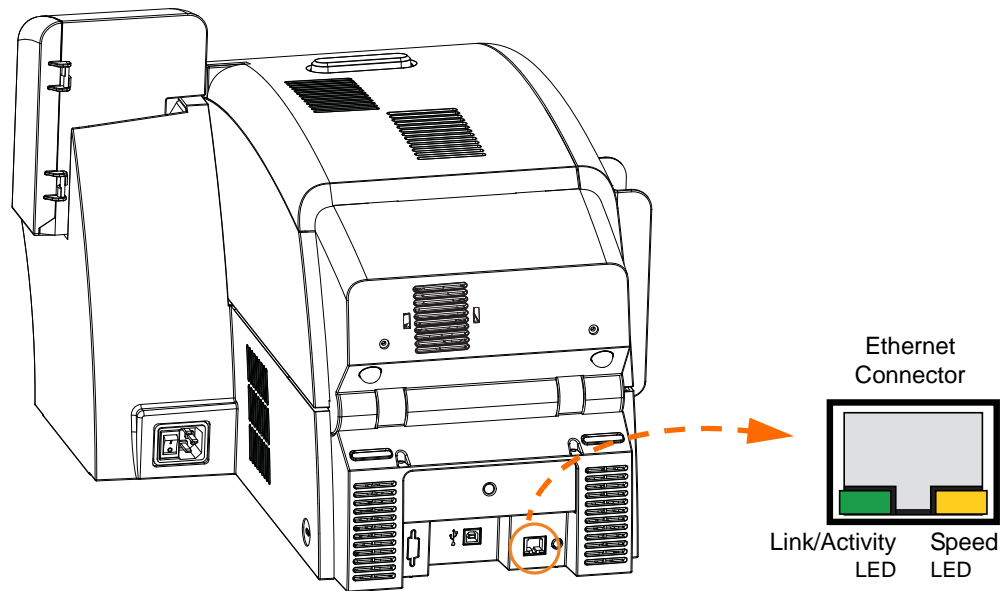

### Link/Activity Indicator (Green)

Off	No link (disconnected)
On	Network link has been established
Blinking	Network activity has been detected

### Speed Indicator (Orange)

Off	No link (disconnected)
1 Blink	The LED blinks once (one blink, pause, one blink, etc.) when a 10Base link has been established.
2 Blinks	The LED blinks twice (two blinks, pause, two blinks, etc.) when a 100Base link has been established.

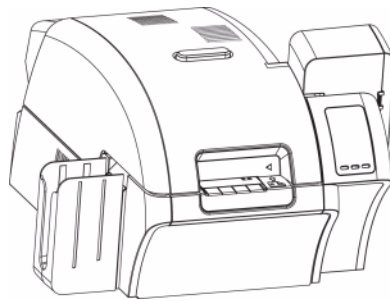



---

# Printer Settings and Adjustments

## Introduction

This section describes settings and adjustments that can be made to your Windows Driver. This consists of two major topics:

Properties . . . . .	52
Printing Preferences . . . . .	60

## Properties

To access Properties, select *Start > Printers and Faxes*. Right click on the *Zebra ZXP Series 8 Card Printer* listing, then select *Properties*

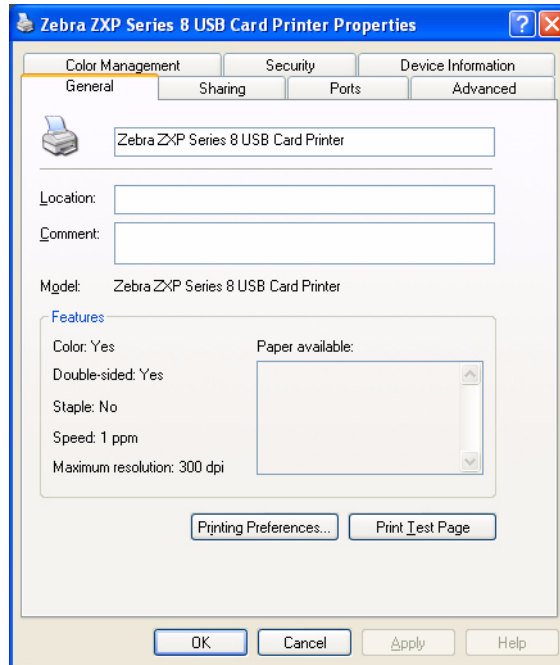

- **General Tab** - Displays printer information of a general nature, includes selection for Printing Preferences and Print Test Page (i.e., the standard Windows test page).
- **Sharing Tab** - Operating System (OS) feature where the printer can be shared with other clients on a network.
- **Ports Tab** - OS feature displays available communication ports.
- **Advanced Tab** - OS feature to select printer availability and spooling options.
- **Color Management Tab** - Allows user to define color profile(s) with color printers.
- **Security Tab** - OS feature where permissions to printers can be defined.
- **Device Information Tab** - Allows user to make basic printer adjustments and access advanced printer controls.



## General Tab

The General tab shows the printer model and lists the features of the printer.

To access the General tab, select *Start > Printers and Faxes*. Right click on the *Zebra ZXP Series 8 Card Printer* listing. Select *Properties > General*.

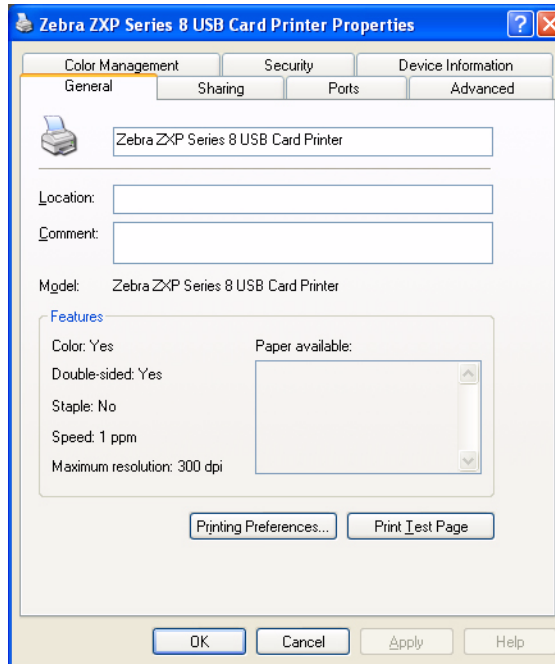

- **Location** - Lets you specify where the printer is located.
- **Comment** - Lets you specify general information about the printer, such as the type of print device and who is responsible for it. Once set, these fields can be displayed by applications.
- **Model** - Specifies the name of the printer driver installed.
- **Features** - Specifies whether various options are available on the printer.

The **Printing Preferences** button takes you to Printing Preferences used to set selected configuration parameters; see [Printing Preferences](#) on page 60

The **Print Test Page** button sends the standard Windows test page to the printer.

## Sharing Tab

On the Sharing tab (Sharing Property Page), you can choose to share the printer over the network and install additional drivers to accommodate different operating systems.

To access the Sharing tab, select *Start > Printers and Faxes*. Right click on the *Zebra ZXP Series 8 Card Printer* listing. Select *Properties > Sharing*.

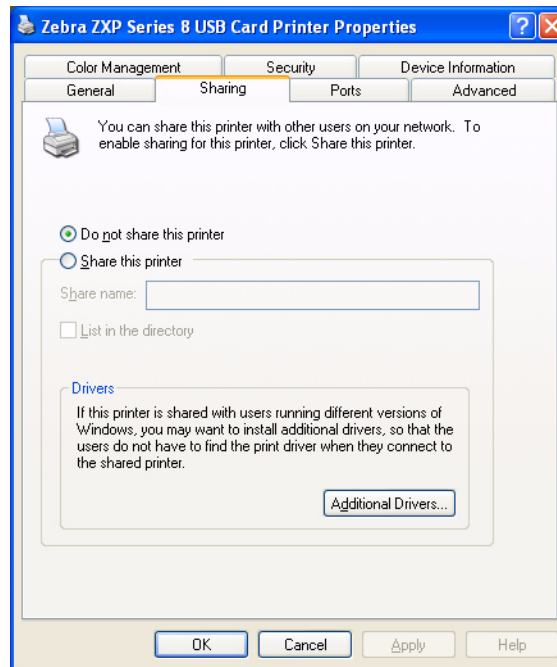

Printer sharing tasks that you can perform include:

- To share a printer, select the *Share this printer* radio button; and specify a name for the shared resource. Click OK when you're finished.
- To change the shared name, simply enter a new name in the *Share name* field; and click OK.
- To quit sharing a printer, select the *Do not share this printer* radio button. Click OK when you're finished.

## Ports Tab

Use the Ports tab to specify the computer port to which the printer is connected. This will have been established at the initial installation of the printer, and will not normally require attention.

To access the Ports tab, select *Start > Printers and Faxes*. Right click on the *Zebra ZXP Series 8 Card Printer* listing. Select *Properties > Ports*.

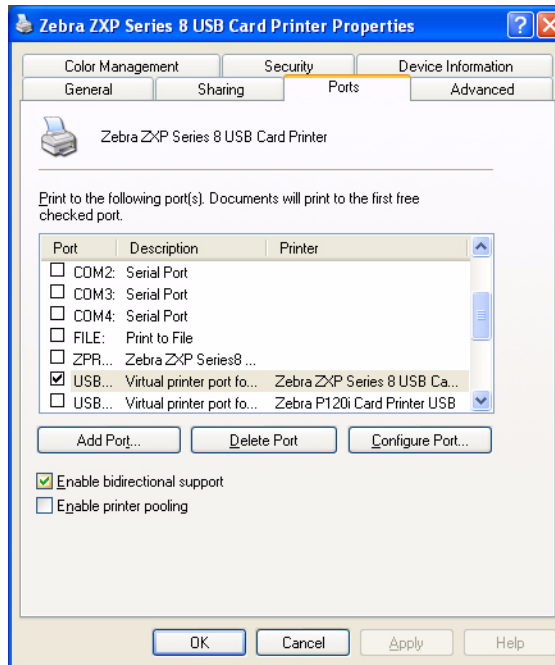

An exception to this is if you wish to use *printer pooling*, the ability to distribute print jobs to multiple printers; see [Pooling](#) on page 169 for details.

To enable printer pooling, check the “Enable printer pooling” box, then check the additional ports boxes. Each port should have a single Zebra printer installed on it. All the pooled printers must be identical models with the same configuration (e.g., all with YMC front, K back); and each must have its own printer driver installed.

Now, when you print to the “main printer” (that is, whichever printer you right-clicked in Printers and Faxes to get to this screen), this printer will get print jobs until it has buffered as many jobs as it can take. Remaining jobs will then “spill over” to other printers until all printers in the pool are busy.

## Advanced Tab

The Advanced tab determines the spooling (queuing) of print jobs and determines how spooled jobs are handled relative to the most recent job.

To access the Advanced tab, select *Start > Printers and Faxes*. Right click on the *Zebra ZXP Series 8 Card Printer* listing. Select *Properties > Advanced*.

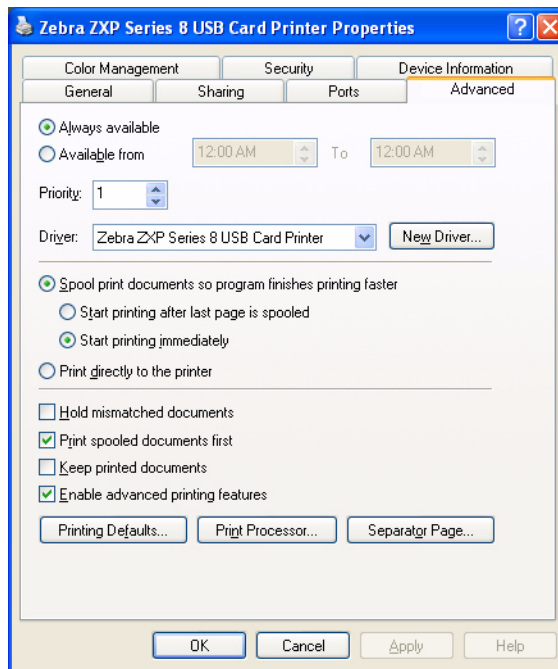

**To enable spooling:** Select the radio button labeled *Spool print documents so program finishes printing faster*.

- Select *Start printing after last page is spooled* if you want the entire document to be spooled before printing begins. This option ensures that the entire document is sent to the print queue before printing. If for some reason printing is canceled or not completed, the job will not be printed.
- Select *Start printing immediately* if you want printing to begin immediately when the print device is not already in use. This option is preferable when you want print jobs to be completed faster or when you want to ensure that the application returns control to users as soon as possible.

**To disable spooling:** Select the radio button labeled *Print directly to the printer* radio button.

## Color Management Tab



**Important** • The optimal color profile is automatically selected when the card type is selected; see the Printing Preferences, **Card Setup Tab**.

Color Management settings allow you to associate color profiles on the printer based on the type of media being used and printer configuration. The **Add** button allows the operator to add additional profiles to the color profile list.

To access the Color Management tab, select *Start > Printers and Faxes*. Right click on the *Zebra ZXP Series 8 Card Printer* listing. Select *Properties > Color Management*.

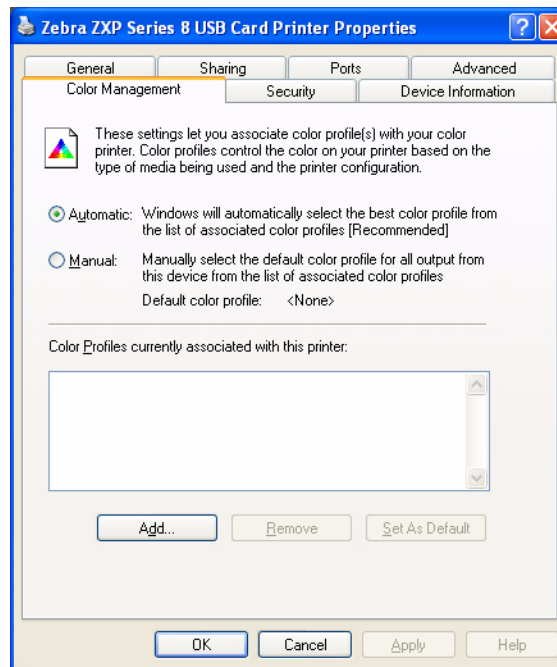

The following settings let you associate color profiles with your printer:

- The **Automatic** radio button lets Windows select the best color profile from the list of associated profiles (default).
- The **Manual** radio button lets you select the appropriate profile from the list shown in the Color Profile window.

You can manage Color Profiles currently associated with your printer as follows:

- The **Add** button allows you to add additional profiles to the color profile list.
- The **Remove** button allows you to remove profiles from the color profile list.
- The **Set As Default** button allows you to set the selected profile as the default profile.

## Security Tab

This is the standard Windows security screen, showing user access to various printer control options. Both Print and Manage Printers *must* be checked for full functionality of the printer.

To access the Security tab, select *Start > Printers and Faxes*. Right click on the *Zebra ZXP Series 8 Card Printer* listing. Select *Properties > Security*.

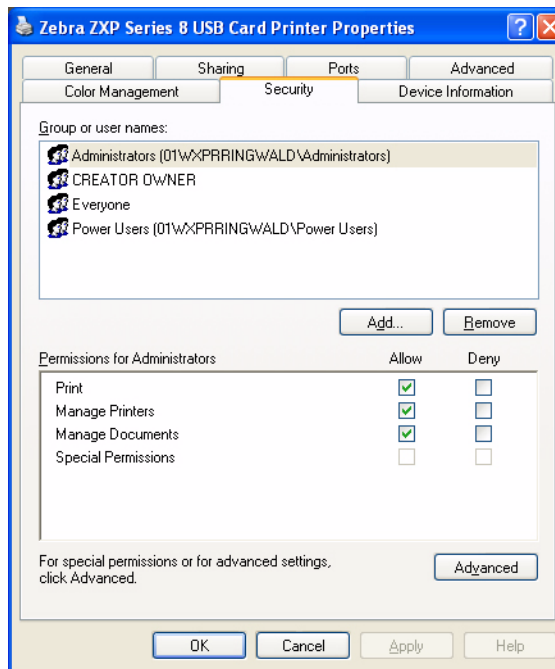

The Security tab allows you to assign the actual permissions that apply to the print queue. You can apply permissions to both users and to groups. It is usually considered a better practice to only apply security to groups.

The Advanced Security Settings properties sheet allows you to assign a more comprehensive set of permissions than the basic Security tab found on the printer's properties sheet does.

## Device Information Tab

The Device Information tab provides device information, security status, and printer usage. Access to Media Info and ZXP ToolBox is included.

To access the Device Settings tab, select *Start > Printers and Faxes*. Right click on the *Zebra ZXP Series 8 Card Printer* listing. Select *Properties > Device Information*.

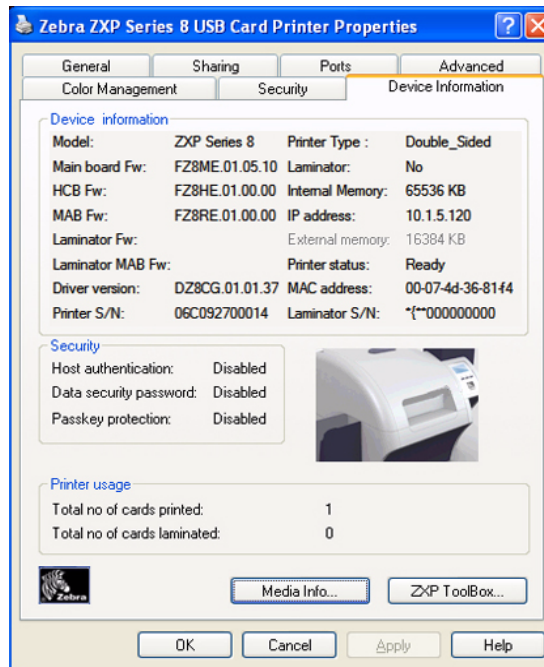

- The **Media Info** button takes you to the Media Info screen which shows:
  - The color ribbon type, part number, and the number of color panel sets remaining
  - The transfer film type, part number, and the number of transfer film panels remaining
- The **ZXP Toolbox** button takes you to the ZXP Toolbox which provides advanced configuration capabilities and tools to manage the operation of your printer; see [Section 5](#) for details.

Note that the ZXP Toolbox is a separate application that works independently from the printer driver.

## Printing Preferences

To access the Printing Preferences, select *Start > Printers and Faxes*. Right click on the *Zebra ZXP Series 8 Card Printer* listing; and select *Printing Preferences*.

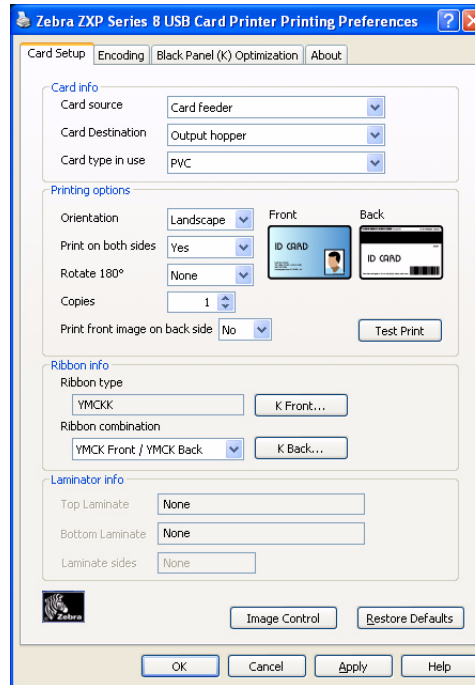

- **Card Setup Tab** - Allows user to adjust selected card and print job parameters.
- **Encoding Tab** - Allows the user to set various magnetic encoding options.
- **Black Panel (K) Tab** - Displays available options for Black Extraction.
- **About Tab** - Displays copyright and driver version information about the printer driver.

The **OK** button saves your settings.

The **Cancel** button abandons changes made.

The **Apply** button applies your settings.

The **Help** button will enable you to view a corresponding page of help information.



## Card Setup Tab

Card Setup tab allows the user to adjust selected card and print job parameters.

To access the Card Setup Tab, select *Start > Printers and Faxes*. Right click on the *Zebra ZXP Series 8 Card Printer* listing; and select *Printing Preferences > Card Setup*.

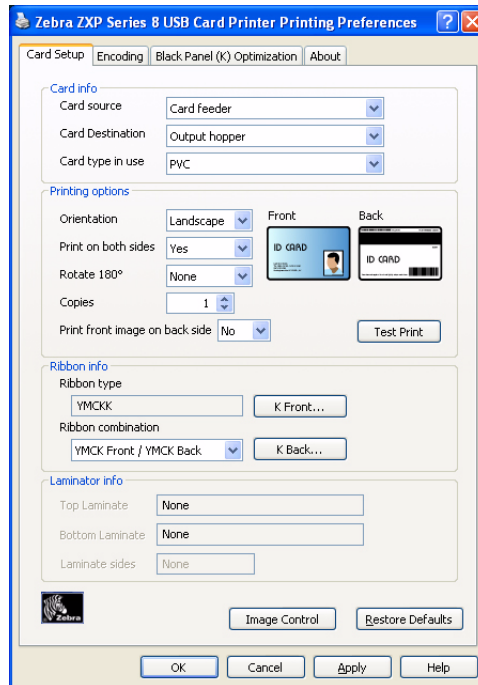

- **Card Info** allows the user to select the Card Source, Card Destination, and Card Type.
  - **Card type in use** allows the user to specify the card type in use. Based on your selection, the printer automatically adjusts various printer properties for optimum print quality.
- **Printing options** allows the user to select the card orientation, to print on both sides of the card, to rotate the card 180°, and to specify the number of copies to print. The **Test Print** button prints a test card.
- **Ribbon info:**
  - **Ribbon type** is the color ribbon installed in the printer. This is not user selectable.
  - **Ribbon combination** allows you to apply color or black, or both, to either side of the card.



## Advanced Black Panel Options Pop-Up

The Advanced Black Panel Options pop-up window allows you to manage and configure Black Extraction. This window is available when using Black Panel (K-Panel) ribbons; e.g., YMCK, YMCKK, etc.

This window controls how the driver selects the text and/or graphics to be printed with the Black Panel.

To access the Advanced Black Panel Options pop-up window, select *Start > Printers and Faxes*. Right click on the *Zebra ZXP Series 8 Card Printer* listing, and select *Printing Preferences > Card Setup*. Select *Ribbon info > K Front ...* or *K Back...*

The figure below shows settings for the front side of the card; settings for the back side of the card are identical.

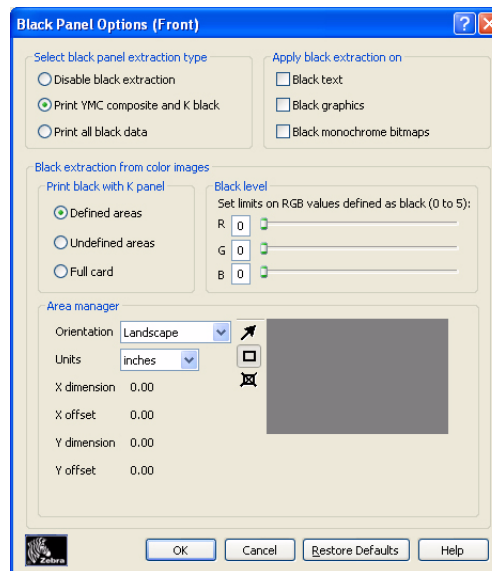

- **Set black panel extraction type:**
  - *Disable black extraction* treats all non-black specified elements as composite black (YMC).
  - *Print YMC black under K* is used to print composite black (YMC) under the K panel. When selected, the operator can choose to do this by selecting certain areas or types of data (e.g., text, graphics, etc) via the **Area manager**.
  - *Print all black data* specifies all black data to be printed with K.
- **Apply black extraction on:** Specify *Black text*, *Black graphics*, or *Black monochrome bitmaps*. The driver will automatically determine the best K-Panel setting based on the card design elements.

- **Black extraction from color images:**

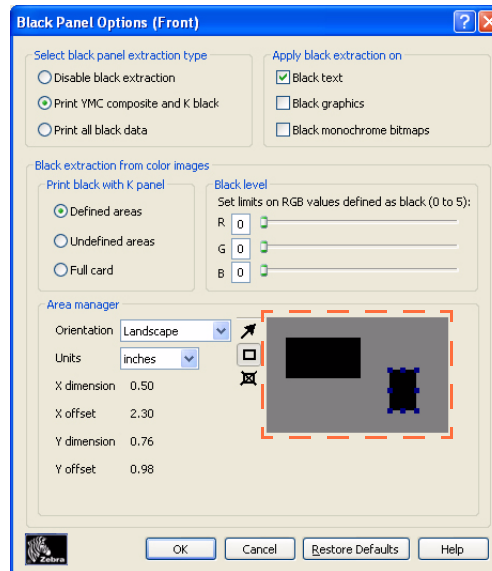



- **Print black with K panel:** Specify the zones as *Defined areas*, *Undefined areas*, or *Full card*.
- **Black level:** The driver evaluates the RGB values of the card design and looks for an RGB value of 000 in order to determine what should be printed in Black.

Using the Black Panel Options, specify what text or graphics, within your card design, are to be printed via composite (YMC) black, K-Resin black, or both.

Then use Black Level to select RGB values higher than the default of 000, to print with the K-resin panel. This allows the range to be expanded up to 555.

- **Area manager:** This option is enabled when either the *Defined areas* (extract inside the zone) or the *Undefined areas* (extract outside the zone) radio button is selected. Note that a defined area is a zone.

This option is used when a particular area of the card has text or other elements that you want treated as **Print black with K panel**.

- Orientation: Set the card orientation to either Portrait or Landscape.
- Units: Set the units to either inches or mm (millimeters)
- Area: Use  to define, select, move, or resize a zone; use  to draw a zone; and use  to delete a selected zone.

To create a zone, “drag” the cursor diagonally across the card area (dashed outline) to define the location of the zone. Note that multiple zones can be defined. Dimensions are referenced to the upper-left corner of the card.

The **Restore Defaults** button restores Advanced Black Panel Options default values.

## Uv Panel Pop-Up

A Uv Panel is a resin-based coating similar to a “K” panel and is used to print invisible images (text or graphics) that will glow in the visible spectrum when exposed to a Black Light.

The Uv Panel pop-up window allows you to manage and configure printing with a Uv Panel. This window is only available when using Uv ribbons (e.g., YMCUvK) and is automatically enabled in the driver when a recognized YMCUvK ribbon is installed.

To access the Uv Panel pop-up window, select *Start > Printers and Faxes*. Right click on the *Zebra ZXP Series 8 Card Printer* listing, and select *Printing Preferences > Card Setup*. Select *Ribbon info > Front Uv...* or *Back Uv...*

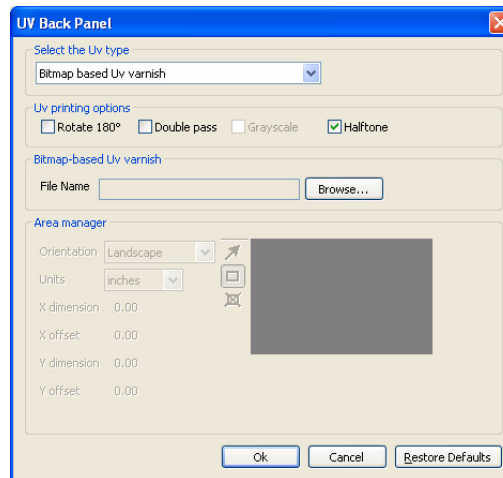

The figure below shows settings for the front side of the card; settings for the back side of the card are identical.

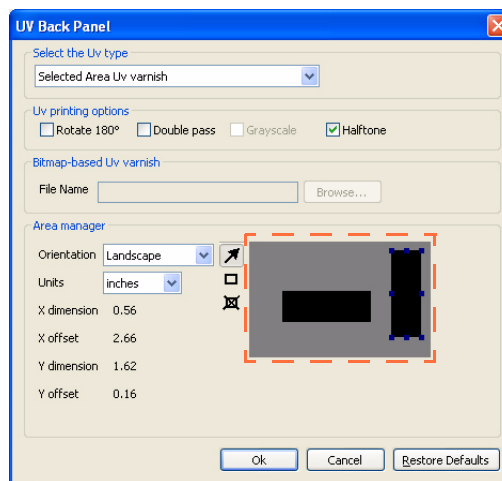

- **Select the Uv type:**
  - *Disable Uv:* Default, no Uv panel will be applied.
  - *Full Uv varnish:* Prints the entire card with full Uv panel.
  - *Selected area blank:* Using the Area Manager (described on next page) allows you to create one or more rectangles to exclude from Uv print.
  - *Selected area Uv varnish:* Using the Area Manager (described on next page) allows you to create one or more rectangles to print.
  - *Bitmap based Uv varnish:* Allows you to import a bitmap image to print on the Uv panel; e.g., import a security seal.

- **Uv printing options:** Note that Rotate 180°, Grayscale, and Halftone are enabled when *Bitmap based Uv varnish* (see above) is selected.
  - Rotate 180°
  - Grayscale
  - Halftone
- **Double pass:** Use this option to optimize the quality of the Uv image. This is a two-step process: 1) print and transfer the card without the Uv image, 2) print and transfer the card a second time with the Uv image only, on top of the existing print image. Note that this option uses an additional transfer panel.
- **Bitmap-based Uv varnish:** This option is enabled when *Bitmap based Uv varnish* (see above) is selected. To locate the bitmap, click on the **Browse** button to bring up a dialog for choosing the file.
- **Area manager:** Note that this option is enabled when either the *Defined areas* or the *Undefined areas* radio button is selected. A defined area is a zone.



- Orientation: Set the card orientation to either Portrait or Landscape.
- Units: Set the units to either inches or mm (millimeters)
- Area: Use  to define, select, move, or resize a zone; use  to draw a zone; and use  to delete a selected zone.

To create a zone, “drag” the cursor diagonally across the card area (dashed outline) to define the location of the zone. Note that multiple zones can be defined. Dimensions are referenced to the upper-left corner of the card.

The **Restore Defaults** button restores Advanced Black Panel Options default values.

## Inhibit Pop-Up

The Inhibit pop-up window allows you to select the inhibit panel area for mag stripe, signature panel, or other non-printing areas of a card. This window is available only when using ribbons with an inhibitor panel; e.g., YMCKi.

To access the Inhibit pop-up window, select *Start > Printers and Faxes*. Right click on the *Zebra ZXP Series 8 Card Printer* listing, and select *Printing Preferences > Card Setup*. Select *Ribbon info > Front Inhibit...* or *Back Inhibit...*

The figure below shows settings for the front side of the card; settings for the back side of the card are identical.

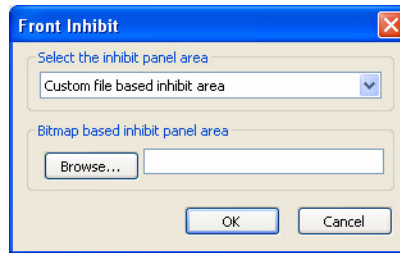

- **Select the inhibit panel area:**
  - *Disable Inhibit*: Default.
  - *Inhibit printing on magnetic stripe*: Places a no-print zone around the mag stripe area.
  - *Inhibit printing on smartcard contact*: Places a no-print zone around the smartcard chip area.
  - *Custom file based inhibit area*: See below.
- **Bitmap based inhibit panel area**: This option is enabled when *Custom file based inhibit area* (see above) is selected. To locate the bitmap, click on the **Browse** button to bring up a dialog for choosing the file.

## Image Control Option

The **Image Control** button brings up the Image Control window, which lets you make color adjustments to compensate for camera or lighting conditions.

Keep in mind that these color adjustments modify how the pictures *print*. The adjustments do not affect the image files. (That type of adjustment would be made in an image processing application program.)

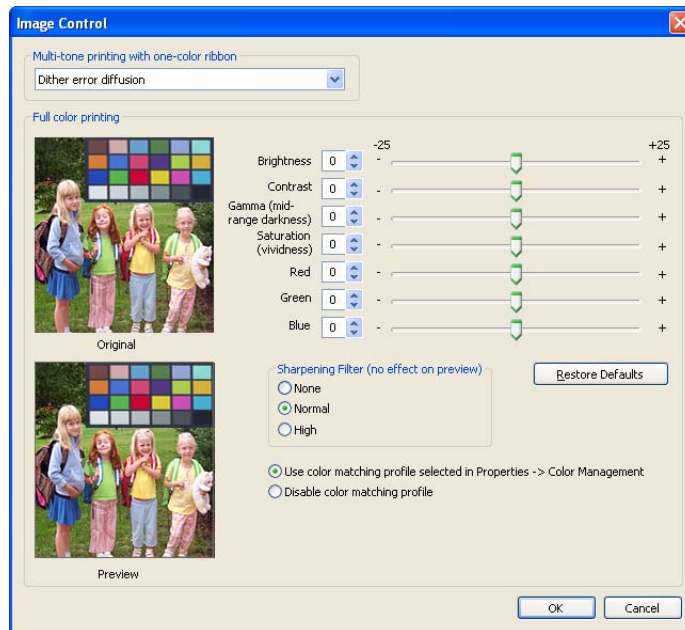

- The **Multi-tone printing with one-color ribbon** dropdown menu lets you select *Dither error diffusion*, *Dither halftoning*, or *Dither pure black on white*.
- **Full color printing** adjustments (-25 to +25 range) include Brightness, Contrast, Gamma, Saturation, Red, Green, and Blue.
- **Sharpening filter** options are None, Normal, and High. Note that these adjustments have no effect on the preview image.

**Color Management:** Depending on the radio button selected, you can use the color matching profile selected in Properties > Color Management or disable the color matching profile.

The **OK** button saves your settings.

The **Cancel** button returns you to the Setup Tab. Changes made are abandoned.

## Encoding Tab

The Encoding screen allows the user to set various magnetic and smart card encoding options.

To access the Encoding Tab, select *Start > Printers and Faxes*. Right click on the *Zebra ZXP Series 8 Card Printer* listing; and select *Printing Preferences > Encoding*.

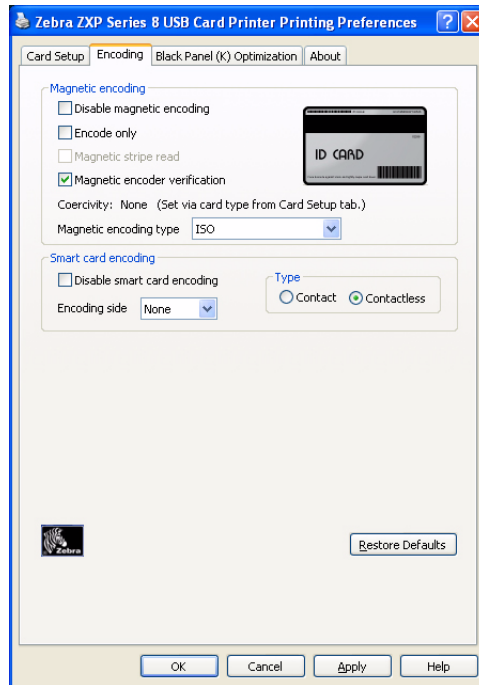

Although these options are user-selectable, they are set automatically when the Card Type is selected in the *Card Setup Tab* on page 61.

- **Magnetic encoder verification:** When selected, the protocol is (1) Write mag data; (2) Verify mag data; (3) If this fails, verify again; (4) If the second verify fails, rewrite and verify; (5) If this cycle fails, eject the card.
- **Magnetic encoding type:** Selections are ISO, AAMVA, CUSTOM, and BINARY; for details see [Magnetic Encoding Type](#) on page 175.

The **Restore Defaults** button restores Encoding default values.



**Note** • For advanced settings, see [Section 5, ZXP Series Toolbox](#).



## Black Panel (K) Tab

The Black Panel (K) Tab allows for special handling of black.



**Note** • The Black Panel (K) Tab applies only to surfaces of the card on which both YMC (color) and K (black) are to be printed.

To access the Black Panel (K) Tab, select *Start > Printers and Faxes*. Right click on the *Zebra ZXP Series 8 Card Printer* listing; and select *Printing Preferences > Black Panel (K)*.

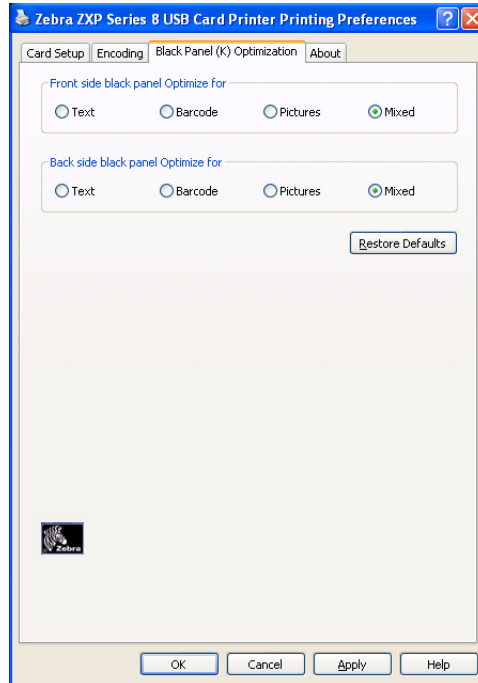

Select the appropriate radio button (Text, Barcode, Pictures, or Mixed) for optimized print quality.

The **Restore Defaults** button restores Black Panel default values.

## About Tab

The About Tab shows the copyright and the driver version for the *Zebra ZXP Series 8 Card Printer*.

To access the About Tab, select *Start > Printers and Faxes*. Right click on the *Zebra ZXP Series 8 Card Printer* listing; and select *Printing Preferences > About*.

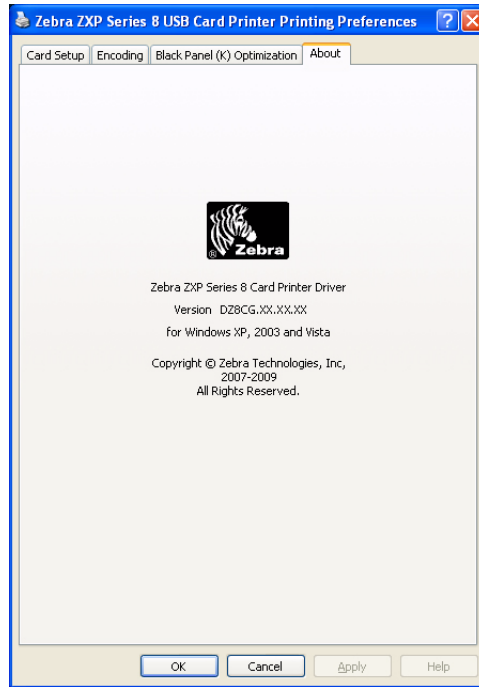



---

# ZXP Series Toolbox

## Introduction



**Important** • Use of the ZXP Series Toolbox is intended only for advanced users and system administrators.

The ZXP Series Toolbox provides advanced configuration capabilities and tools to manage the operation of your printer. Note that the ZXP Series Toolbox is a separate application that works independently from the printer driver.

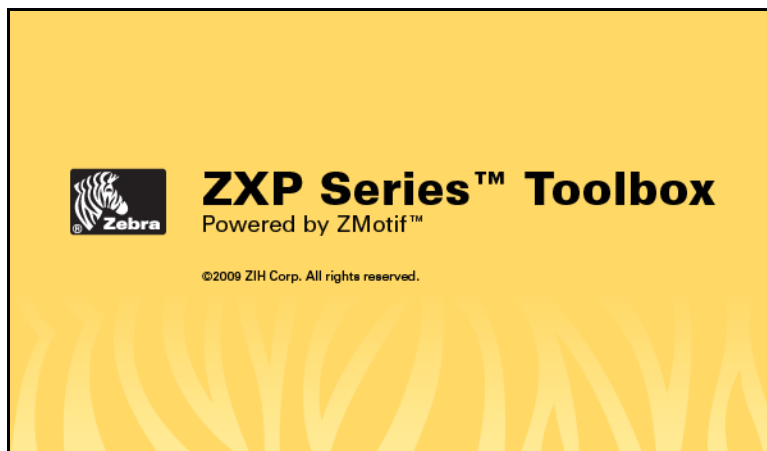

## ZXP Series Toolbox Access

To access the ZXP Series Toolbox from the printer driver, select *Start > Printers and Faxes*. Then right-click on the *Zebra ZXP Series 8 Card Printer* listing, and select *Properties > Device Information > ZXP ToolBox*.

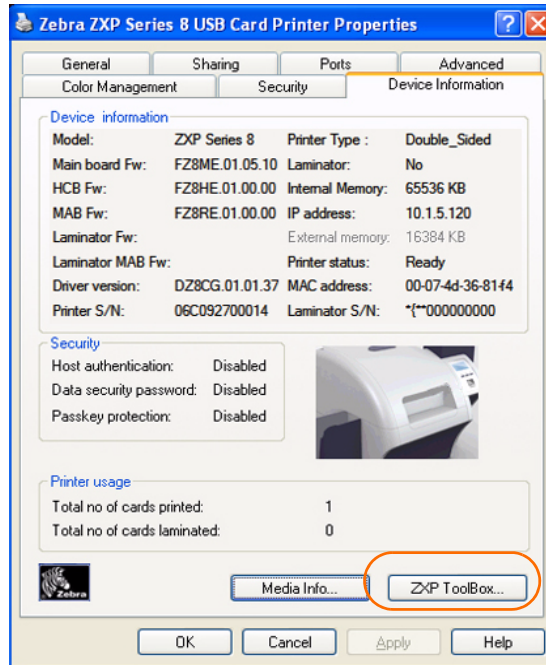

The ZXP Series Toolbox can also be accessed via *Start > All Programs > Zebra ZXP Series 8 Card Printer > ZXP ToolBox*.

## Information

### Printer

This information cannot be edited or changed by the user; however, this information may be useful for Zebra trained and certified personnel in diagnosing or evaluating printer status.

- **Firmware and Driver** lists the versions of the Firmware (Firmware, HCB, and MAB) and the version of the Driver.

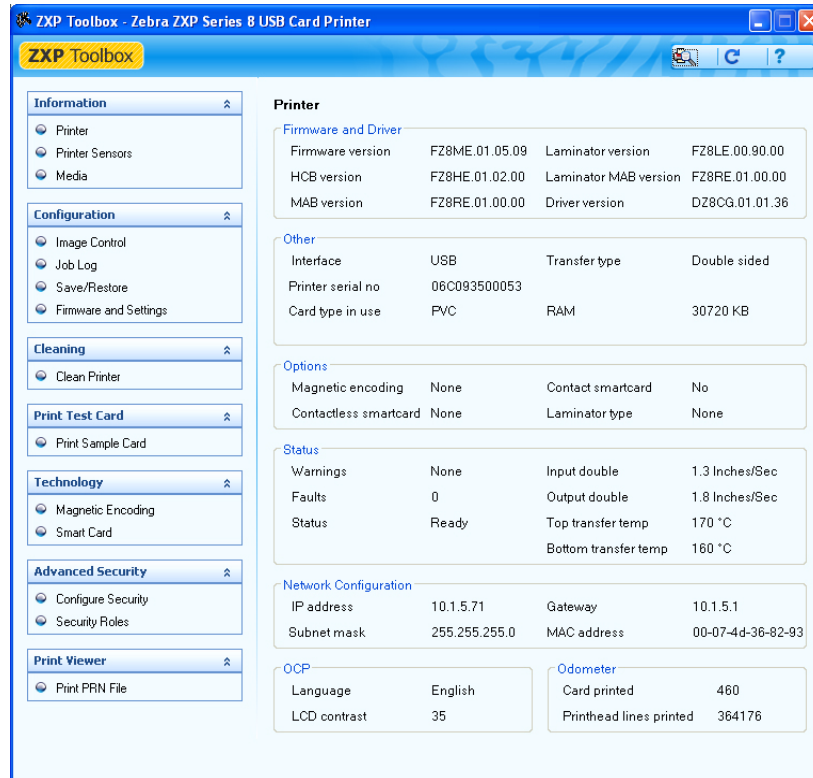

Printer			
<b>Firmware and Driver</b>			
Firmware version	FZ8ME.01.05.09	Laminator version	FZ8LE.00.90.00
HCB version	FZ8HE.01.02.00	Laminator MAB version	FZ8RE.01.00.00
MAB version	FZ8RE.01.00.00	Driver version	DZ8CG.01.01.36
<b>Other</b>			
Interface	USB	Transfer type	Double sided
Printer serial no	06C093500053		
Card type in use	PVC	RAM	30720 KB
<b>Options</b>			
Magnetic encoding	None	Contact smartcard	No
Contactless smartcard	None	Laminator type	None
<b>Status</b>			
Warnings	None	Input double	1.3 Inches/Sec
Faults	0	Output double	1.8 Inches/Sec
Status	Ready	Top transfer temp	170 °C
		Bottom transfer temp	160 °C
<b>Network Configuration</b>			
IP address	10.1.5.71	Gateway	10.1.5.1
Subnet mask	255.255.255.0	MAC address	00-07-4d-36-82-93
<b>OCP</b>		<b>Odometer</b>	
Language	English	Card printed	460
LCD contrast	35	Printhead lines printed	364176

- **Other** shows the Interface, the Transfer type, and the Card type in use, RAM, and Printer serial no.
- **Options** shows the options installed -- Magnetic encoding, Contact smartcard, and Contactless smartcard.
- **Status** displays Warnings, Faults, and Status; Input and Output speeds (single and double); Top and Bottom transfer temperatures.
- **Network Configuration** lists the IP address, Gateway, Subnet mask, and MAC address.
- **OCP** shows the Language displayed in the Operator Control Panel and the LCD contrast level selected.
- **Odometer** shows the number of Cards printed and the number of Printhead lines printed.

## Sensors

These characteristics cannot be edited or changed by the user; however, this information may be useful for Zebra trained and certified personnel in diagnosing or evaluating printer sensors status.

- **Sensor States** details the state of each printer sensor.

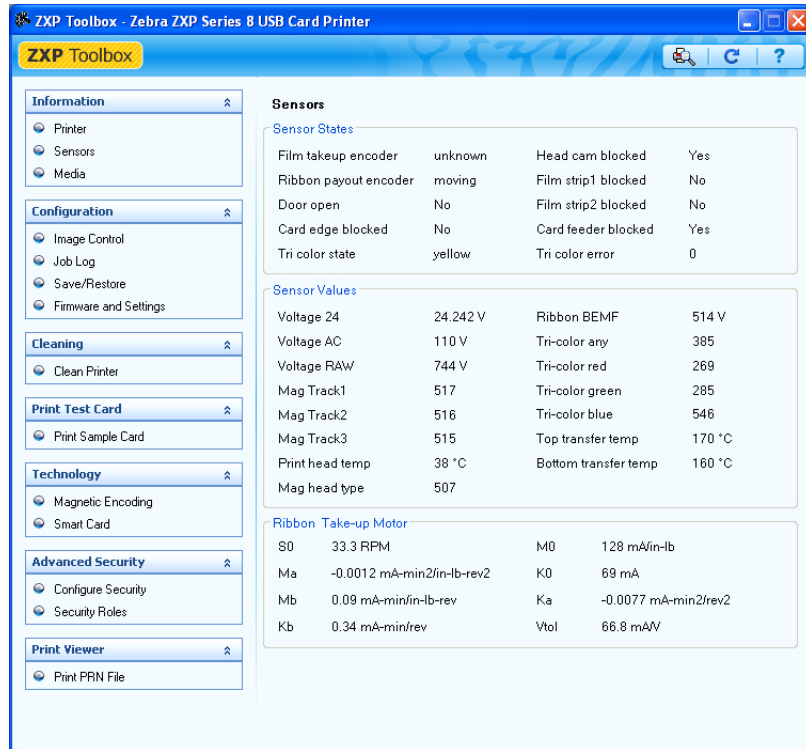

- **Sensor Values** details the value of each printer sensor.
- **Ribbon Take-up Motor** lists various electrical characteristics of the motor.

## Media

This screen displays ribbon and transfer film. This data is automatically read and updated from the installed media in the printer.

- **Ribbon Details** include Type, Description, Zebra part number, Initial size, Images remaining.

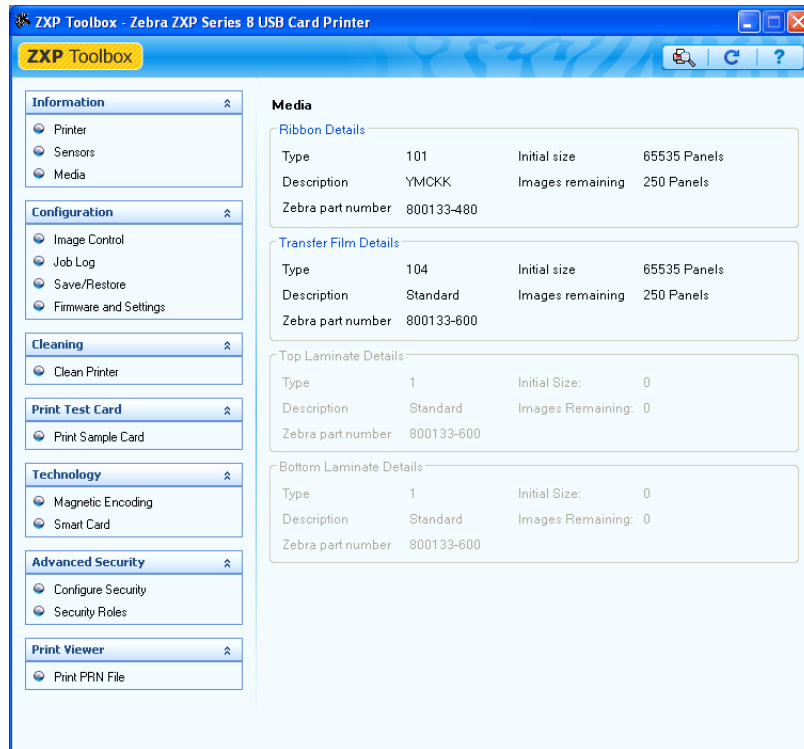

- **Transfer Film Details** include Type, Description, Zebra part number, Initial size, Images remaining.

## Configuration

### Image Control

The Image Control window lets you make color adjustments to compensate for camera or lighting conditions.

Keep in mind that these color adjustments modify how the pictures *print*. The adjustments do not affect the image files. (That type of adjustment would be made in an image processing application program.)

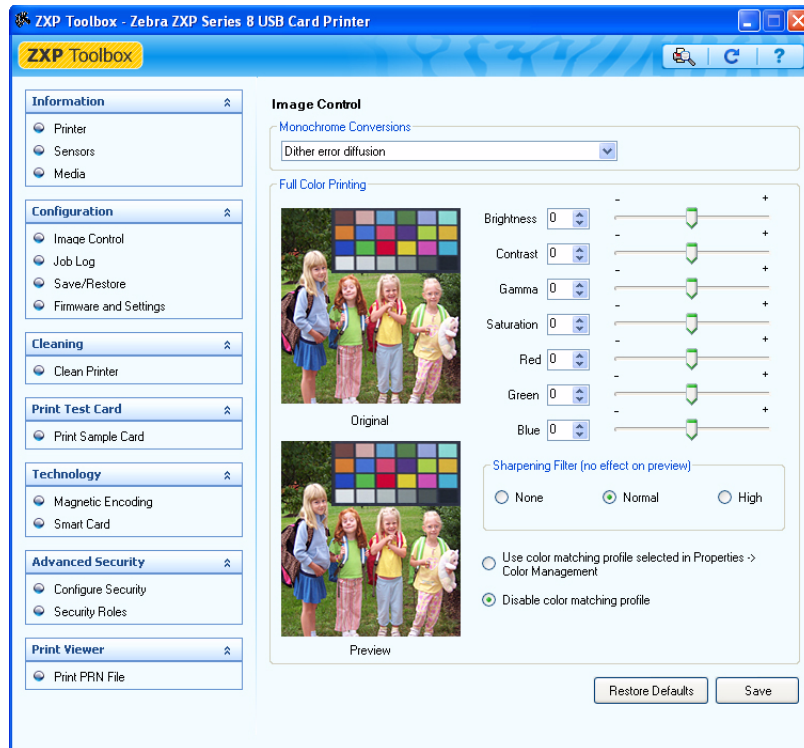

- The **Monochrome Conversions** dropdown menu lets you select *Dither error diffusion*, *Dither halftoning*, or *Dither pure black on white*.
- **Full Color Printing** adjustments (-25 to +25 range) include Brightness, Contrast, Gamma, Saturation, Red, Green, and Blue.
- **Sharpening Filter** options are None, Normal, and High. Note that these adjustments have no effect on the preview image.

Depending on the radio button selected, you can use the color matching profile selected in *Properties > Color Management* or you can disable the color matching profile.

The **Save** button saves your image control settings.

The **Restore Defaults** button restores the image control default values.



## Job Log



**Note** • Job Logs and Printer Logs are stored in the following default location:  
*C:\Documents and Settings\All Users\ZMotif*

The Job Log is a utility that builds a database of card transactions in the printer's host computer. The Job Log records the data encoded on the card's magnetic stripe, together with date, time, and the printer's serial number.

The data set can be uploaded at any time to a central archive, thus providing a means for security officers to validate a card by comparing it with tamper-proof *real data*.

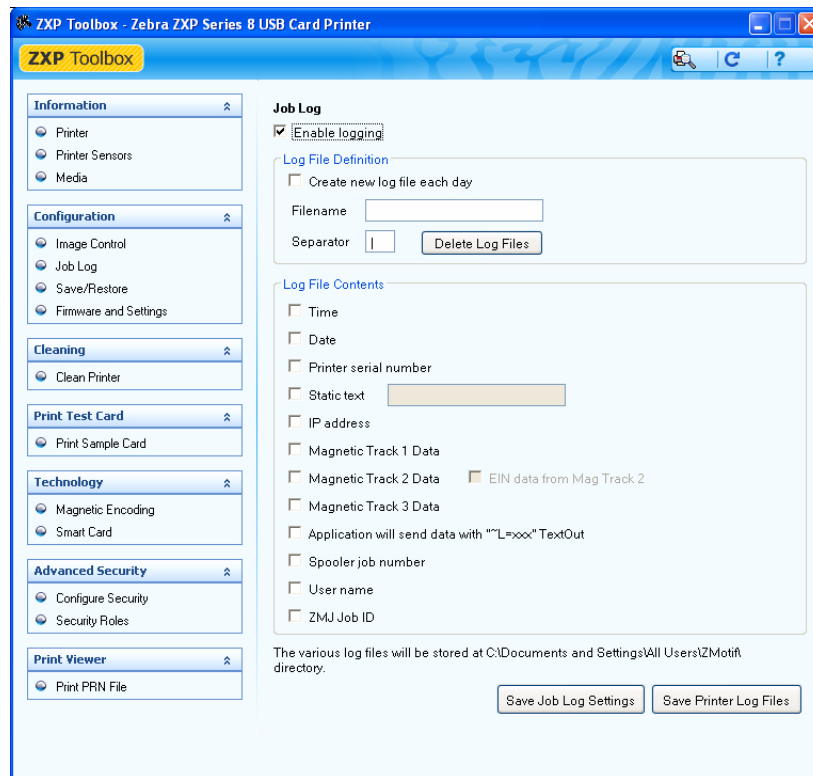

- **Enable logging** - If this box is checked, the logging feature is enabled.
- **Log File Definition** - Choose one of the following options:
  - If the “Create new log file each day” box is unchecked, the data is saved to a log file of your choice (Filename).
  - If the box is checked, the data is saved to log file *ZXPLog* with the day's date; e.g., *ZXPLog\_2009\_3\_4*.
  - In addition to the Filename, you may wish to enter a special field Separator Character. The default field Separator Character is “|”.

- **Log File Contents** - The Log File Contents group selects the data to be logged in the file you specified above. The data will be logged in the order displayed on the screen, each field being separated by the character specified in the Logfile Definition, Separator.

Log File Contents selections include:

- **Time:** Logs the time at which the card was sent to the printer in the HH:MM:SS format. The 24-hour clock is used, so 13:00:00 = 1:00 pm, and 05:00:00 = 5:00 am.
- **Date:** Logs the date the card was sent to the printer in the MM/DD/YYYY format.
- **Printer serial number:** Logs the serial number of the printer that printed the card.
- **Static text:** Adds to the record text in the box at right, 16 characters maximum.
- **IP address:** Logs the IP address of the PC that sent the card to the printer.
- **Magnetic Track 1, 2, 3 Data:** Logs the data sent to the printer to be encoded on the card's magnetic stripe.
- **EIN data from Mag Track 2:** Not implemented.
- **Application will send data with “~L=xxx” TextOut:** Allows third-party applications to send data to be logged in much the same way as they would send magnetic data.
- **Spooler job number:** Logs the number which the card print job was assigned in the Windows print spooler.
- **User name:** Logs the username of the person submitting the card print job.
- **ZML Job ID:** Logs the UUID; or, in a Windows environment, the GUID.



**Note** • Job Logs and Printer Logs are stored in the following default location:  
*C:\Documents and Settings\All Users\ZMotif*

The **Save Job Log Settings** button saves the Job Log settings.

The **Save Printer Log Files** button creates the following XML Log Files:

- GetLogCleanHistory.xml
- GetLogErrors.xml
- GetLogEventHistory.xml
- GetLogServiceHistory.xml

## Save/Restore

When you set up a printer, you can save the printer and driver configuration settings; then, when you restore or add additional printers, you can use the saved configuration to ensure configuration consistency.

Note that the Saved/Restored Settings (circled below) are for the Printer.

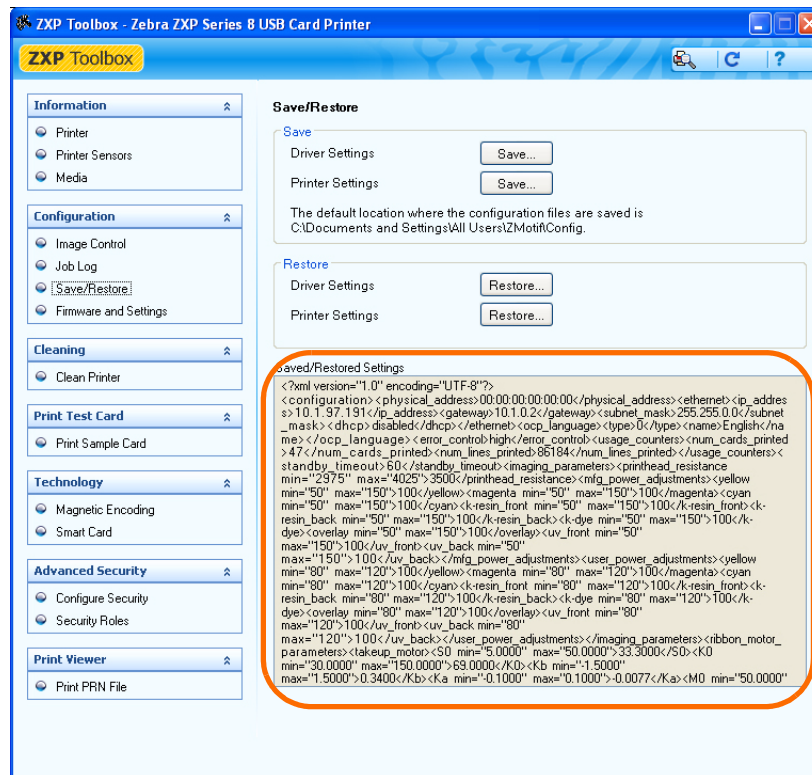

**Note** • The configuration files are stored in an XML format in the following default location:  
*C:\Documents and Settings\All Users\ZMotif\Config*

- The **Save** buttons save the Driver Settings and/or Printer Settings in an XML file format.
  - The printer configuration settings are stored as P\_<filename>
  - The driver configuration settings are stored as D\_<filename>
- The **Restore** buttons restore the Driver Settings and/or Printer Settings.

## Firmware and Settings

The Firmware Download screen allows you to download firmware and firmware updates. Note that firmware updates can also be found at <http://zebracard.com> under *Drivers & Downloads*.

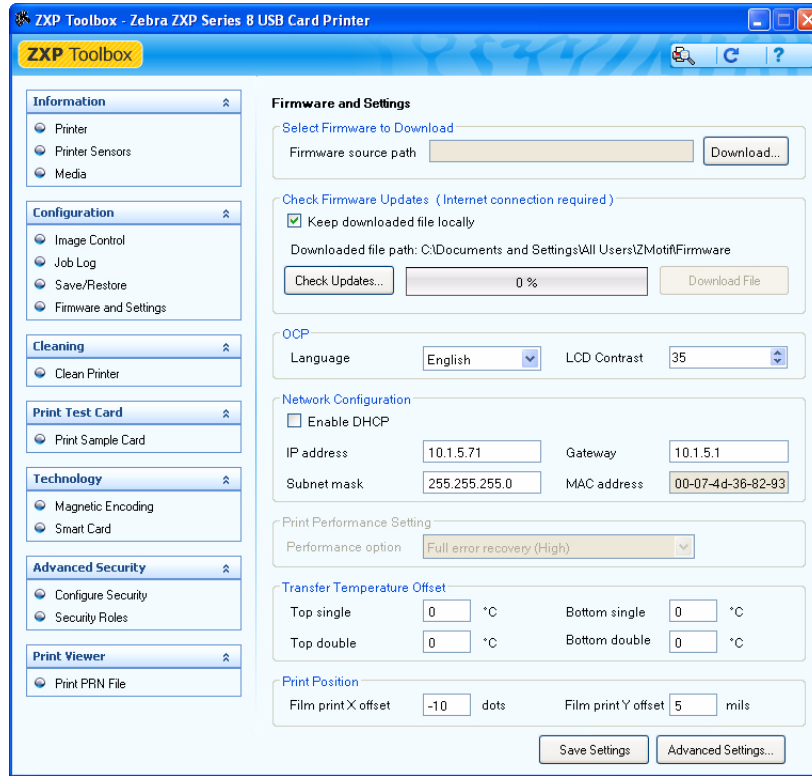

- **Select Firmware to Download:** Use this option to install the firmware downloaded from the Zebra web site to a directory on your computer.
  1. Click on the **Download** button.
  2. From the Browse window, “find” the downloaded firmware (BIN file type), and click on the **Open** button.
  3. Read the *ZXP Toolbox* caution message. If you are satisfied with the download, click on the **OK** button to install the firmware; otherwise click on the **Cancel** button to abandon the firmware installation.

- **Check Firmware Updates:** To use this option, you must have an internet connection.

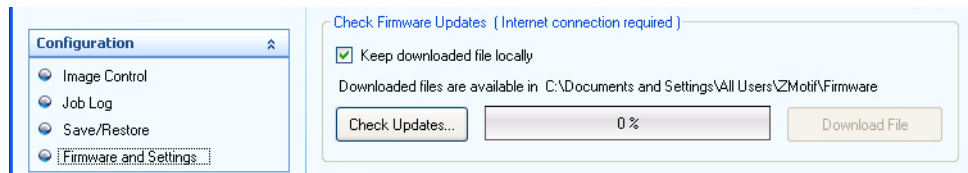

1. Click on the **Check Updates** button.
  2. Enter the Server name, User name, and Password in the *Ftp Login* pop-up, and click on the **OK** button.
  3. Observe the firmware update file(s) displayed in the Filename listing.
  4. Select the desired update file from the list.
  5. Click on the **Download File** button.
  6. As the file is downloaded, observe the % complete bar. If you selected the the *Keep downloaded file locally* checkbox, the update file will also be saved to your computer at *C:\Documents and Settings\ZMotif\Firmware*.
  7. Click the **OK** button when the *Download completed* pop-up appears.
  8. Read the *ZXP Toolbox* caution message. If you are satisfied with the download, click on the **OK** button to install the firmware; otherwise click on the **Cancel** button to abandon the firmware installation.
- **OCP:** This section allows you to change the Language displayed in the Operator Control Panel (English, French, Spanish, German, Brazilian Portuguese, or Italian) and adjust the LCD Contrast level selected (the level ranges from 20 to 50).
  - **Network Configuration:** This section allows you to change the various network configuration parameters (DHCP, IP address, Gateway, Subnet mask, and MAC address).
  - **Print Performance Setting:** Performance options from the dropdown menu include:
    - Standard performance and error handling
    - Optimized for performance
    - Optimized for error recovery

- **Temperature and Position Settings**

The screenshot shows a configuration window with a sidebar on the left and a main settings area on the right. The sidebar has two sections: 'Advanced Security' with options 'Configure Security' and 'Security Roles', and 'Print Viewer' with the option 'Print PRN File'. The main area is titled 'Transfer Temperature Offset' and contains four input fields: 'Top single' (0 °C), 'Bottom single' (0 °C), 'Top double' (0 °C), and 'Bottom double' (0 °C). Below this is a section titled 'Print Position' with two input fields: 'Film print X offset' (0 dots) and 'Film print Y offset' (0 mils). At the bottom right of the main area are two buttons: 'Save Settings' and 'Advanced Setting ...'.

- Transfer Temperature Offset:



**Note** • While you will not see a change in card parameters for a given card type when using the *Transfer Temperature Offsets*, you will see the change in the OCP Info screen that shows the temperature set-points and current temperatures.

Transfer Temperature Offset is provided to globally change the temperature of the heated rollers. If you have a single card type that you want to change the roller temperatures, you would use custom card type. If the printer seems to be running too cold or too hot for every card type, you would use this adjustment to raise or lower the heated roller temperature for all cards. This will not affect what you see in the card parameters for a given defined card type; see Note above. The adjustment range is: Minimum -10, Maximum 10.

- Print Position:

Film print X offset (dots): This is the number of dots (300 dpi / ~3 mils/dot.) to shift the image to align it on the media. Increasing these values move the image right while decreasing them moves the image left. This parameter can be used to center the image on the card, or to align it with an edge. The adjustment range is: Minimum -50, Maximum 50.

Film print Y offset (mils): This is the number of mils to shift the image to align it on the media. Increasing these values moves the image up while decreasing them moves the image down. This parameter can be used to center the image on the card, or to align it with an edge. The adjustment range is: Minimum -100, Maximum 100.

The **Save Settings** button saves any changes you have made to this screen.

The **Advanced Setting** button provides access to service-related tests and adjustments. Use is password protected and limited to Zebra-authorized service personnel.

# Cleaning

## Clean Printer

The Clean Printer screen gives you the option to clean the printer via the Toolbox; refer to [Section 6](#), for cleaning via the OCP.

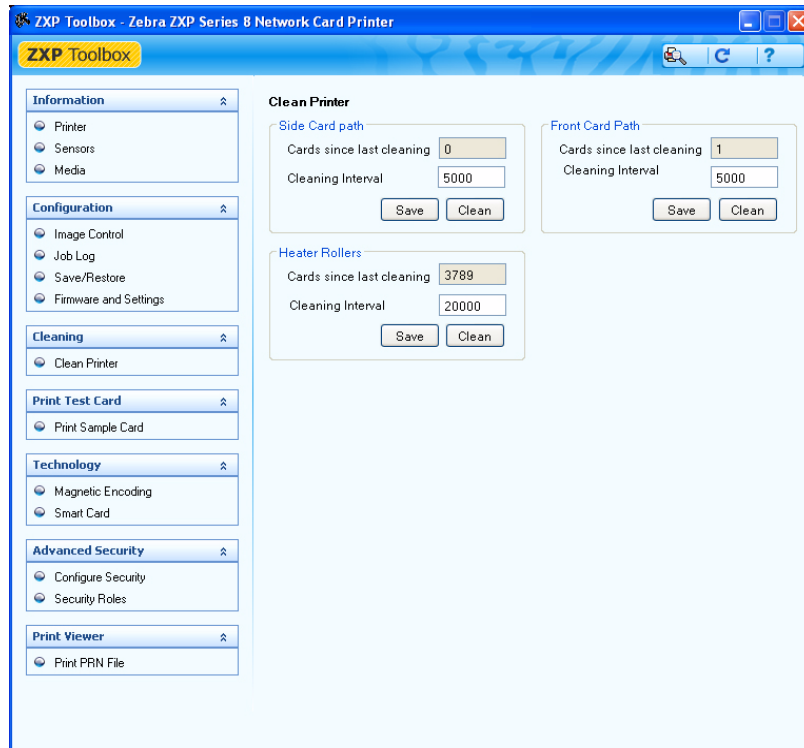

- **Side Card Path**

When you click on the **Clean** button, instructions will appear in the following sequence:

1. Remove the card hopper, and click Ok.
2. Insert the X Roller Cleaning Card in the side slot where the card hopper was located. Click Ok after inserting the cleaning card.
3. Wait until the cleaning process completes. The card will eject through the side slot.
4. Flip the cleaning card. Insert the card through the side slot. Click Ok.
5. Wait until the cleaning process completes. The card will eject through the side slot.
6. Observe the message, *Side card path cleaning successful*.
7. This concludes the side card path cleaning process.

- **Front Card Path**

When you click on the **Clean** button, instructions will appear in the following sequence:

1. Insert the Y Roller Cleaning Card in the front feed slot. Click Ok after inserting the card.
2. Wait until the cleaning process completes. The card will eject through the front feed slot.
3. Flip the cleaning card. Insert the card through front feed slot. Click Ok.
4. Wait until the cleaning process completes. The card will eject through the front feed slot.
5. Observe the message, *Front card path cleaning successful*.
6. This concludes the front card path cleaning process.

- **Heater Rollers**

When you click on the **Clean** button, instructions will appear in the following sequence:

1. Open the printer cover, remove the transfer film, and close the cover. Then, click Ok.
2. Observe the top and bottom transfer temperatures cool. Wait until the transfer temperatures fall below 70°C before proceeding to the next step.
3. Remove the backing from the Hot Roller Cleaning Card. Insert the card in the front feed slot. Click Ok.
4. Wait until the cleaning process is completed. The card will eject through the front feed slot.
5. Flip the cleaning card. Insert card in the front feed slot. Click Ok.
6. Wait until cleaning process is completed. The card will eject through the front feed slot.
7. Replace the transfer film.
8. Observe the message, *Transfer roller cleaning successful*.
9. This concludes the heater roller cleaning process.



## Print Test Card

### Print Sample Card



**Note** • The sample cards in the Test Card Library are .bmp images stored in the following default location: *C:\Documents and Settings\All Users\ZMotif\Library*

1. View the **Test Card Library**. Use the scrollbar to view all the selections.

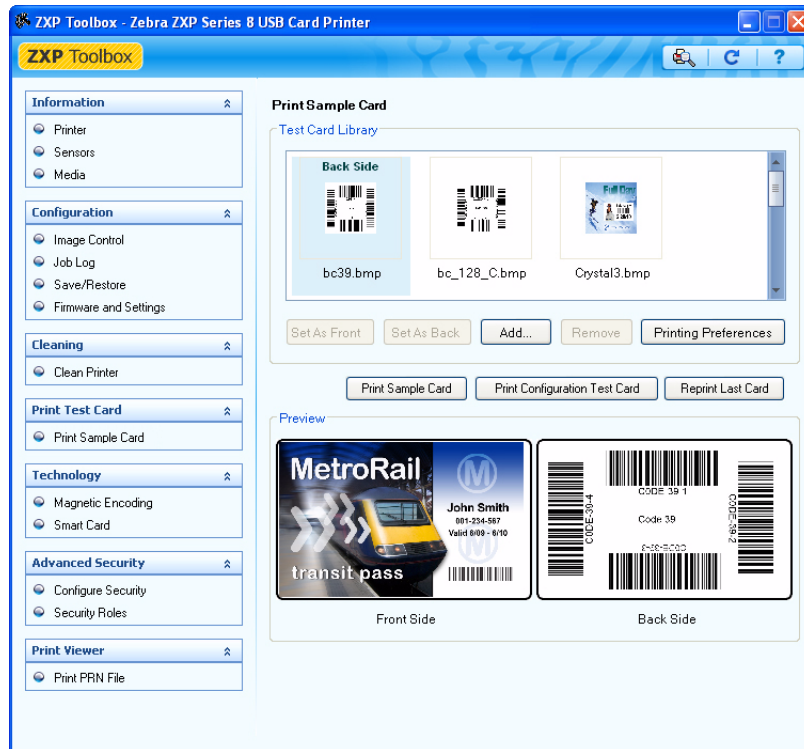

2. Set the front side:
  - a. Select (click on) a card from the Test Card Library.
  - b. Click on the **Set As Front** button.
  - c. View the selected card in the Preview. Note that to remove the selected card from the Preview, click on the **Set As Front** button.
  - d. To change your selection, repeat Steps **a** through **c**.
3. Set the back side: same as Step **2**, except click on the **Set As Back** button.
4. When satisfied with your selection, click on the **Print** button to print the sample card.

The **Printing Preferences** button takes you to the Printer Preferences, Card Setup Tab.

The **Print Configuration Test Card** button provides printer configuration data on a card.

The **Reprint Last Card** button sends a command to the printer to print the last card.

## Technology



**Note** • Magnetic Encoding and Smart Card default values are set via the *Card type in use* option in the Card Setup tab, [see page 61](#))

### Magnetic Encoding

The Magnetic Encoding screen allows the user to test various magnetic encoding options. For more information on magnetic encoding, refer to [Appendix D](#).

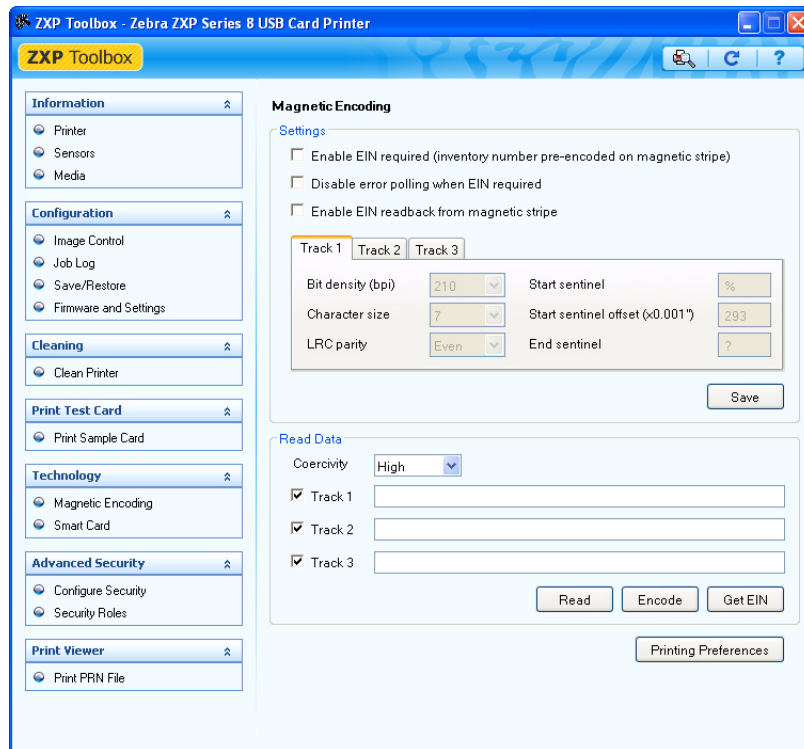

Settings: EIN options not implemented.

Read Data:

- Coercivity: Select either *High* or *Low*.
- Track selection:
  - For encoding: Click on the checkboxes to select *Track 1*, *Track 2*, and/or *Track 3*; enter the data to be written; and click on the **Encode** button.
  - For reading: Click on the checkboxes to select *Track 1*, *Track 2*, and/or *Track 3*; click on the **Read** button, and validate the data read.

## Smart Card

The Smart Card screen allows the user to test various smart card encoding options. For more information on smart card encoding, refer to [Appendix E](#).

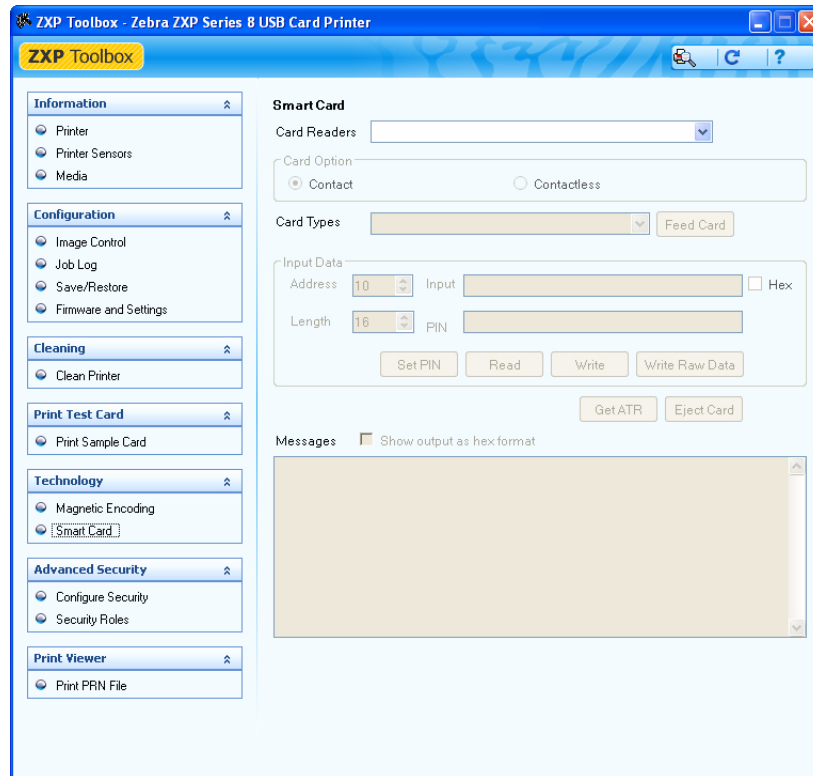

- Card Readers: Select the card reader from the drop-down menu.
  - Card Option: Select either Contact or Contactless.
- Card Types: Select the card type from the drop-down menu.
  - The **Feed Card** button feeds the card into the printer.
  - Input Data includes address, length, input, and PIN.
    - Click on the **Set PIN** button to set the security code for the card.
    - Click on the **Read** button to read data from the card.
    - Click on the **Write** button to write data to the card.
    - Click on the **Write Raw Data** button to write “raw data” to a card.
- The **Get ATR** button returns the ATR (Answer To Reset) result from the card reader. This is useful to identifying the type of smart card inserted into the printer.
- The **Eject Card** button ejects the card.
- Click on the **Messages** checkbox to show the output in hex format.

## Advanced Security



**Important** • To manage this section, you are required to be the administrator of the local computer or have administrative privileges.

### Configure Security

Enabling driver password protection prevents unauthorized persons from changing the printer configuration settings. Access to various printer screens can be selectively disabled based on the Windows User Login.

#### Textbox Password:

To enter a new password:

1. Enter the new password on the *New password* field. The password is case sensitive, eight characters minimum.

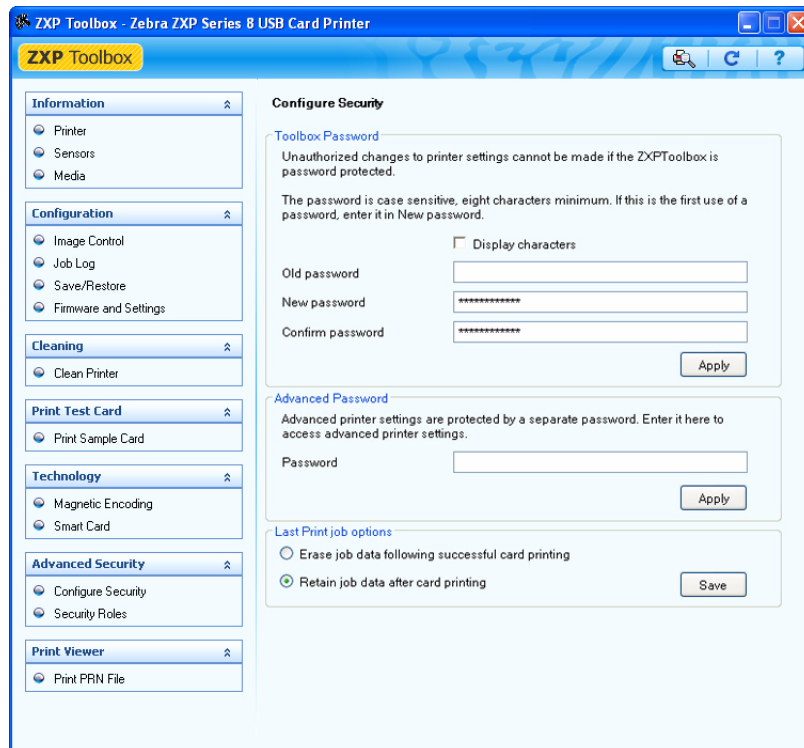

2. Repeat the password in the *Confirm password* field.
3. Click on the **Apply** button.

To change the Password:

1. Enter your password in the *Old password* field.

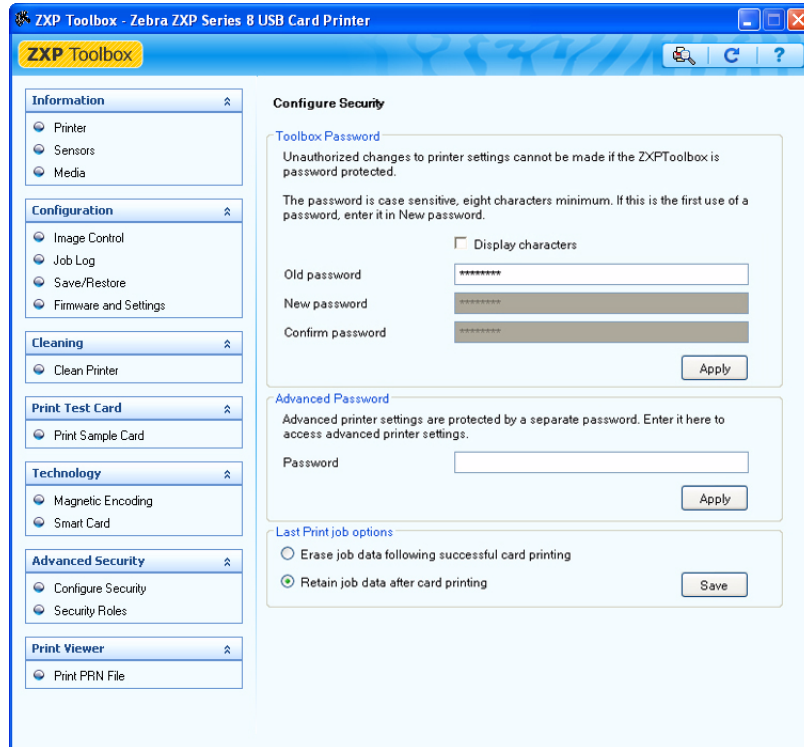

2. Enter the new password in the *New password* and the *Confirm password* fields.
3. Click on the **Apply** button.

### Advanced Password:

This password provides access to service-related tests and adjustments via the **Advanced Setting** button; see [Firmware and Settings](#) on page 80. Use is limited to Zebra-authorized service personnel.

### Last Print job option:

- The *Erase job data following successful card printing* option erases the print job after successful card printing.
- The *Retain job data after card printing* option allows the print job to remain in memory for multiple prints via the OCP.

The **Save** button saves your selection.

## Establish Security Roles



**Important** • To manage this section, you are required to be the administrator of the local computer or have administrative privileges.

Use this section used to establish security roles; i.e., grant and restrict access to various ZXP Series Toolbox screens. The list of users in the drop-down menu (e.g., Guest, HelpAssistant, Local User, localfix, etc.) is derived from the list of users on the system.

To set security access roles:

1. Select a user from the drop-down menu.

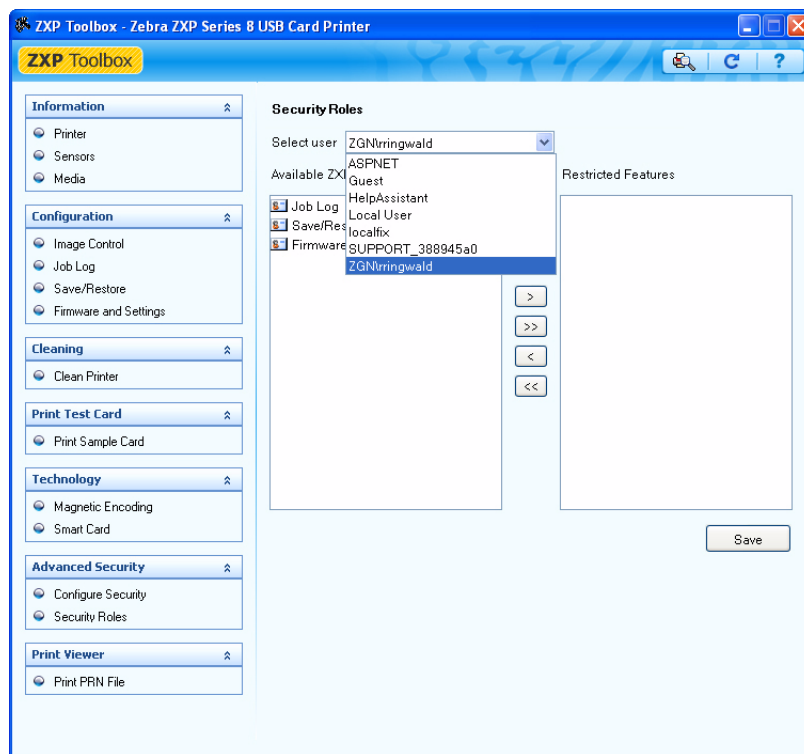

2. Use the arrow buttons (>, >>, <, and << ) to make specific features available to or restrict specific features from the selected user role.
3. When satisfied with the selection, click on the **Save** button.

At the next log in, the user will only see or have access to the features previously granted.

## Print Viewer

When you print a PRN file, you print directly to the printer, bypassing computer applications and associated printer drivers. This utility can be used to ensure that your printer is working properly by isolating it from driver-related and communication-related issues.

### Print PRN file



**Note** • Sample PRN files are stored in the following default directory/folder:  
*C:\Documents and Settings\All Users\ZMotif\Library*

To send a PRN file to the printer:

1. Click on the **Browse** button.

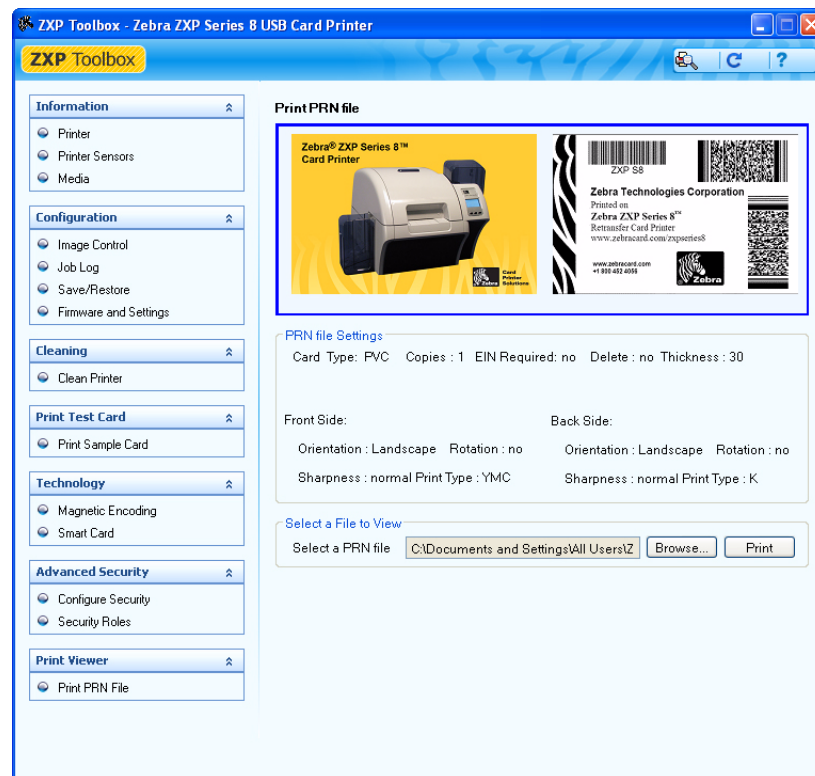

2. From the Browse window, locate and select a PRN file.
3. Click on the **Open** button.
4. View the PRN file.
5. When satisfied with the selection, click on the **Print** button.

Successfully printing the PRN file indicates that the printer and data communications to the printer are set up and configured properly.

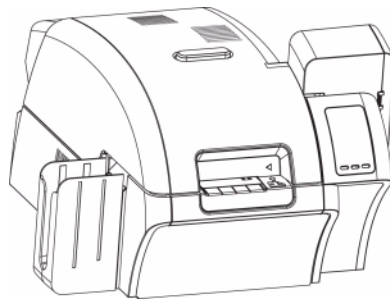





---

# Cleaning

---

**Caution • PROTECT YOUR FACTORY WARRANTY!**



The recommended cleaning procedures must be performed to maintain your factory warranty. Other than the recommended cleaning procedures described in this manual, allow only Zebra authorized technicians to service the Printer.

**NEVER** loosen, tighten, adjust, bend, etc., any part or cable inside the printer.

**NEVER** use a high pressure air compressor to remove particles in the printer.

---

## Cleaning the Printer

Clean your Printer using the Cleaning Cards provided. The regular use of these cards will clean and maintain important parts of your printer that cannot be reached, including the Printhead, Transport Rollers, and optional Magnetic Encoder Station.

### When to Clean

- X-Roller and Y-Roller cleaning should occur every 5,000 cards.
- Heated Roller cleaning should occur every 20,000 cards. Note that a Heated Roller Cleaning Card is not supplied with the printer; order Zebra Cleaning Card Kit P/N 105999-801.

## Cleaning the Rollers



**Note** • Do not use previously used cleaning cards.

**Step 1.** Initiate the cleaning process.

- a. Press the MENU button on the Operator Control Panel (OCP). The OCP will display the Main Menu.
- b. Scroll through the Main Menu, and select Advanced Settings. The OCP will display the Advanced Settings Menu.
- c. Scroll through the Advanced Settings Menu, and select Clean Printer. The OCP will display the Clean Printer Menu.

**Step 2.** Clean the X-Drive Rollers.

- a. Select *Clean Side Card Path* to run the X-Roller Cleaning Routine.
- b. Use the X-Roller Cleaning Card.
- c. Follow the OCP instructions.

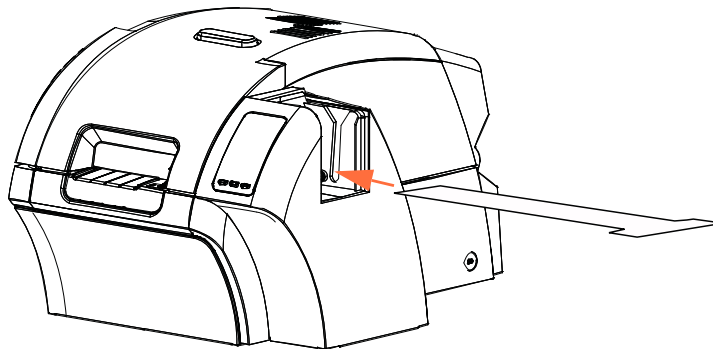

- d. When complete, the OCP will return to the Clean Printer Menu.

**Step 3.** Clean the Y-Drive Rollers.

- a. Select *Clean Front Card Path* to run the Y-Roller Cleaning Routine.
- b. Use the Y-Roller Cleaning Card.
- c. Follow the OCP instructions.

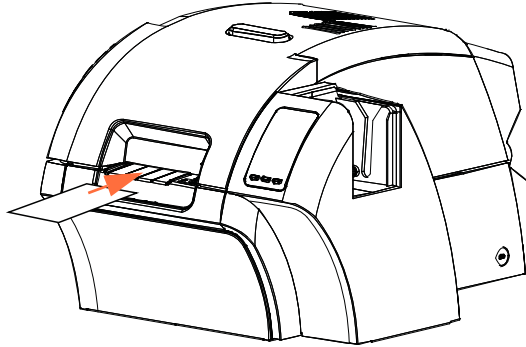

- d. When complete, the OCP will return to the Clean Printer Menu.

**Step 4.** Clean the Heated Rollers.

- a. Select *Clean Transfer Path* to run the Heated Roller Cleaning Routine.
- b. Use the Hot Roller Cleaning Card.
- c. Follow the OCP instructions.

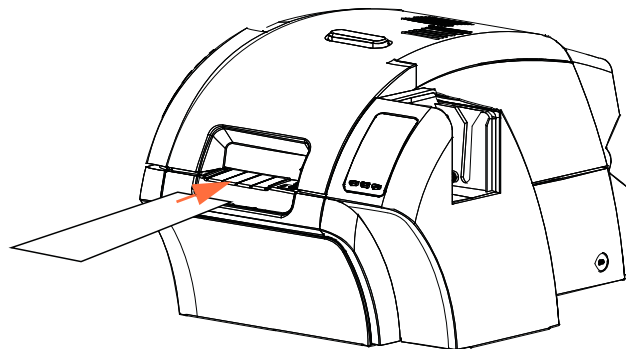

- d. When complete, the OCP will return to the Clean Printer Menu.
- e. Then use the Heated Roller Cleaning Card to clean the Platen; see [page 96](#).

Exit the Printer Menus by selecting RETURN at each menu level (Clean Printer Menu, Advanced Settings Menu, and Main Menu).

## Cleaning the Platen

**Step 1.** Open the printer Door.

**Step 2.** Remove the Transfer Film.

**Step 3.** Manually run the Hot Roller Cleaning Card over the Platen.

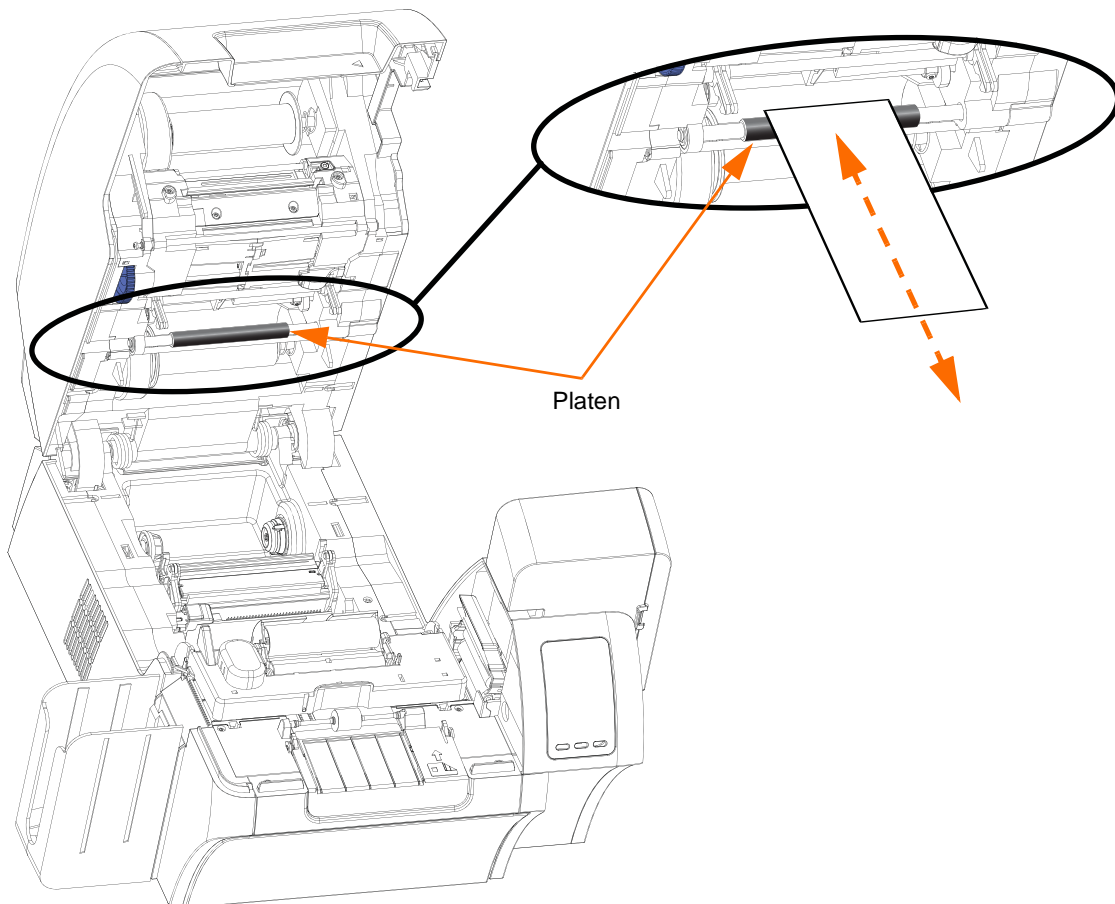

**Step 4.** Re-install the Transfer Film.

**Step 5.** Close the printer Door.

## Cleaning the Printhead

Printhead cleaning removes deposits when print anomalies persist. To avoid deposits, only use foam-tipped swabs or pens.



---

**Caution** • Never use a sharp object or any abrasive to scrape deposits from the Printhead. Permanent damage to the Printhead will result.



---



---

**Caution** • Do not touch the Printhead if the printer has been in service in the last 10 minutes. It could be very hot and cause a burn.

---

- Step 1.** Place the printer power switch in the OFF (  ) position.
- Step 2.** Open the Door, and remove the print ribbon.
- Step 3.** Bend the Cleaning Swab to release the cleaning fluid.
- Step 4.** Clean Printhead by moving Cleaning Swab tip side-to-side across the Printhead elements. Only use moderate force. To re-order Cleaning Swabs, see the *Media List* on the **User Documentation and Drivers CD** supplied with this printer.
- Step 5.** Reinstall the print ribbon, and close the Door.
- Step 6.** Place the printer power switch in the ON (  ) position.

## Card Cleaning Cartridge

The Card Cleaning Cartridge cleans the cards entering the printer through the card feeder. To ensure print quality, the card cleaning roller requires periodic replacement. New card cleaning rollers are included with each print ribbon or may be purchased separately. (To reorder, refer to the *Media List* on the **User Documentation and Drivers CD** supplied with this printer.)

Installation of the Card Cleaning Cartridge is described in [Section 2](#) and is not repeated in detail here.



**Note** • Before replacing the Card Cleaning Cartridge or its adhesive roller, clean the Printer using the Cleaning Cards as described earlier in this chapter.

## Card Cleaning Roller

The Card Cleaning Roller cleans the cards entering and exiting the Transfer Station. To ensure print quality, the card cleaning roller requires periodic replacement. A new card cleaning roller is included with each print ribbon or may be purchased separately. (To reorder, refer to the *Media List* on the **User Documentation and Drivers CD** supplied with this printer.)

Installation of the Card Cleaning Roller is described in [Section 2](#) and is not repeated in detail here.

# Troubleshooting



The table on the next page offers causes and solutions to symptoms related to improper operation. Check the table when experiencing any loss of operation or print quality.

Use the following figure in conjunction with the table to help locate the possible cause and effect a solution.

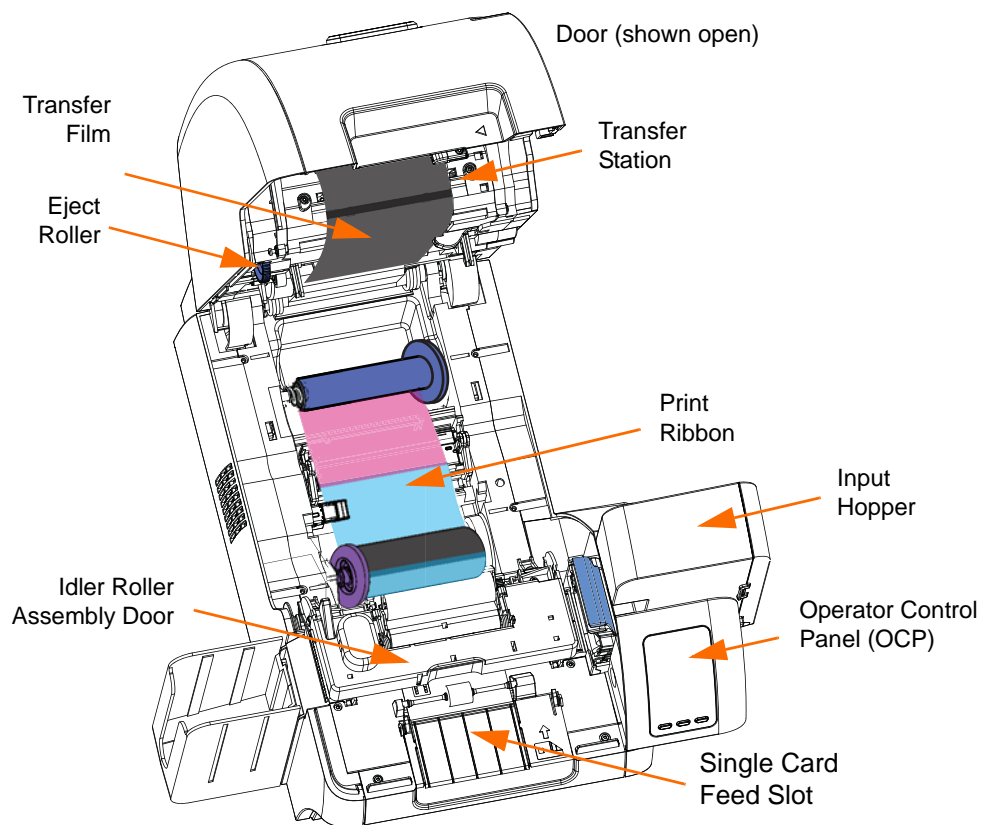

## OCP Error Messages

ERROR MESSAGE	POSSIBLE CAUSE	POSSIBLE SOLUTION
BOTTOM LAMINATE FEED *	<ul style="list-style-type: none"> <li>Bottom laminate cartridge is not installed properly.</li> <li>Cartridge is not removed when that side of the card is not being laminated.</li> </ul>	<ul style="list-style-type: none"> <li>Remove, reposition, and re-install the bottom laminate cartridge.</li> <li>Remove the bottom laminate cartridge.</li> </ul>
BOTTOM LAMINATE OUT *	The bottom laminate has run out.	Load new roll of laminate.
BOTTOM LAMINATE REGISTRATION *	<ul style="list-style-type: none"> <li>Improperly prepared registered laminate.</li> <li>Media misfeed.</li> <li>Patch length improperly set.</li> <li>Unexpected end of laminate roll detected.</li> </ul>	Remove and recut laminate in the center of the index notch, re-install, and retry.
CARD CLEAN ERROR	<ul style="list-style-type: none"> <li>Faulty Card Cleaning Roller (if error during single card feed).</li> <li>Faulty Card Cleaning Cartridge (if cards fed from Input Hopper).</li> </ul>	Replace the Card Cleaning Roller or Card Cleaning Cartridge, as appropriate.
CARD EJECT ERROR	Card from previous job is stuck in the exit area.	Remove the card from the exit area.
CARD FEED ERROR	Card is jammed in Input Hopper.	<ol style="list-style-type: none"> <li>Clear the card jam in the Input Hopper, and re-seat the Input Hopper.</li> <li>Ensure that cards are not stuck together and that they are the correct thickness (30 - 40 mil).</li> </ol>
CARD JAM	Card is jammed in Card Transport or Transfer Station.	<p>Check the card path:</p> <ol style="list-style-type: none"> <li>Idler Roller Assembly (open door).</li> <li>Transfer Station (rotate the eject roller CCW).</li> <li>Check printer-to-laminator area for a jammed card. *</li> </ol>
CARD NOT DETECTED	Card did not reach card sensor or is jammed in Input Hopper or Card Transport.	<ol style="list-style-type: none"> <li>Clear the card jam in the Input Hopper, and re-seat the Input Hopper.</li> <li>Ensure that cards are not stuck together and that they are the correct thickness.</li> <li>Check Idler Roller Assembly (open door).</li> </ol>
CARD NOT INSERTED	Card was not fed into Single Card Feed Slot within nominal 30-second period.	Retry and feed card into the Single Card Feed Slot, or cancel the operation.

\* Message only applies to Printers with a Laminator.



ERROR MESSAGE	POSSIBLE CAUSE	POSSIBLE SOLUTION
CONTACT READ ERROR	<ul style="list-style-type: none"> <li>• Faulty card.</li> <li>• Incorrect card orientation.</li> <li>• Incorrect Mode or Protocol setting.</li> <li>• Faulty reader.</li> </ul>	<ul style="list-style-type: none"> <li>• Try another card.</li> <li>• Try another card (check orientation).</li> <li>• Correct the Mode or Protocol setting.</li> <li>• Contact Zebra Technical Support.</li> </ul>
CONTACT WRITE ERROR	<ul style="list-style-type: none"> <li>• Faulty card.</li> <li>• Incorrect card orientation.</li> <li>• Incorrect Mode or Protocol setting.</li> <li>• Faulty writer.</li> </ul>	<ul style="list-style-type: none"> <li>• Try another card.</li> <li>• Try another card (check orientation).</li> <li>• Correct the Mode or Protocol setting.</li> <li>• Contact Zebra Technical Support.</li> </ul>
CONTACTLESS READ ERR	<ul style="list-style-type: none"> <li>• Faulty card.</li> <li>• Incorrect Mode or Protocol setting.</li> <li>• Faulty reader.</li> </ul>	<ul style="list-style-type: none"> <li>• Try another card.</li> <li>• Correct the Mode or Protocol setting.</li> <li>• Contact Zebra Technical Support.</li> </ul>
CONTACTLESS WRITE ERR	<ul style="list-style-type: none"> <li>• Faulty card.</li> <li>• Incorrect Mode or Protocol setting.</li> <li>• Faulty writer.</li> </ul>	<ul style="list-style-type: none"> <li>• Try another card.</li> <li>• Correct the Mode or Protocol setting.</li> <li>• Contact Zebra Technical Support.</li> </ul>
COVER OPEN	Door is ajar.	Verify the Door is completely closed.
EP SCRIPT ERROR	Internal logic error.	<ol style="list-style-type: none"> <li>a. Power cycle the printer.</li> <li>b. Contact Zebra Technical Support.</li> </ol>
ETHERNET COMM ERROR	Ethernet communication problem.	<ol style="list-style-type: none"> <li>a. Disconnect and reconnect the network cable.</li> <li>b. Power cycle the printer.</li> <li>c. Contact Zebra Technical Support.</li> </ol>
FILM JAM	The transfer film is jammed.	<ol style="list-style-type: none"> <li>a. Check the transfer film.</li> <li>b. Reinstall the transfer film.</li> <li>c. Repair the break in the transfer film and reinstall.</li> </ol>
FILM MOTION ERROR	Transfer film not correctly responding to motion commands.	<ol style="list-style-type: none"> <li>a. Check the transfer film.</li> <li>b. Reinstall the transfer film.</li> <li>c. Power cycle the printer.</li> <li>d. Contact Zebra Technical Support.</li> </ol>
FW UPGRADE ERROR	Invalid firmware version selected.	Verify the version, and retry updating the firmware.
GENERAL MEMORY ERROR	There is a problem when accessing memory.	<ol style="list-style-type: none"> <li>a. Power cycle the printer.</li> <li>b. Contact Zebra Technical Support.</li> </ol>
HCB BULB ERROR	The Halogen Controller Board (HCB) is unable to pulse the upper and lower heaters to bring the upper and lower rollers to the proper temperature.	Contact Zebra Technical Support.
HCB SENSOR ERROR	The Halogen Controller Board (HCB) is unable to detect temperature of the upper or lower rollers.	Contact Zebra Technical Support.

ERROR MESSAGE	POSSIBLE CAUSE	POSSIBLE SOLUTION
INVALID BOTTOM LAMINATE *	Laminate does not match the type allowed in the laminator or top and/or bottom has been swapped.	<ul style="list-style-type: none"> <li>a. Verify that the top and bottom laminate cassettes are installed in the correct locations.</li> <li>b. Verify the part number of the laminate is correct on OCP.</li> <li>c. Power cycle the printer.</li> </ul>
INVALID CARD TYPE	Encoding error.	<ul style="list-style-type: none"> <li>a. Ensure that you are using the correct card type.</li> <li>b. Ensure that the card orientation is correct for the card type.</li> <li>c. In the Encoding tab of the driver, check that the settings are correct for the cards you are using.</li> <li>d. Ensure that the data conforms to ISO Specifications.</li> <li>e. Retry writing and reading.</li> </ul>
INVALID FILM	Transfer film does not match the printer.	<ul style="list-style-type: none"> <li>a. Verify the part number of the transfer film is correct on OCP.</li> <li>b. Power cycle the printer.</li> </ul>
INVALID RIBBON	Print ribbon does not match the printer.	<ul style="list-style-type: none"> <li>a. Verify the part number of the print ribbon is correct on OCP.</li> <li>b. Power cycle the printer.</li> </ul>
INVALID TOP LAMINATE *	Laminate does not match the printer.	<ul style="list-style-type: none"> <li>a. Verify the part number of the laminate is correct on OCP.</li> <li>b. Power cycle the printer.</li> </ul>
LAMINATOR BOTTOM CUTTER FAIL *	Bottom cutter has failed.	Contact Zebra Technical Support.
LAMINATOR BOTTOM CUTTER STALL *	Bottom cutter blade is obstructed, or bottom cutter mechanism is damaged.	Contact Zebra Technical Support.
LAMINATOR BOTTOM HEATER FAIL *	Bottom heater did not turn on after being instructed to do so. When the heater is enabled, the controller will wait a certain specified amount of time for it to attain the set target temperature. If the heater fails to reach the target in the specified time, the BotHeaterFail fault will be set.	<ul style="list-style-type: none"> <li>a. Replace the bottom halogen bulb.</li> <li>b. Contact Zebra Technical Support.</li> </ul>
LAMINATOR BOTTOM TEMP SENSOR FAIL *	The bottom temperature (thermopile) sensor has failed.	Contact Zebra Technical Support.
LAMINATOR BOTTOM TEMPERATURE HIGH *	If the bottom roller temperature ever exceeds a fixed temperature threshold, the over temp error occurs.	<ul style="list-style-type: none"> <li>a. Power cycle the printer.</li> <li>b. Contact Zebra Technical Support.</li> </ul>
LAMINATOR CARD FEED *	Printer has not fed the card far enough into laminator mechanism for infeed rollers to grab it.	Open the Laminator and printer doors to check for jammed/stuck cards
LAMINATOR COVER OPEN *	This warning will be displayed if the cover protecting the laminator is opened.	This warning will be cleared when the laminator cover is closed.

\* Message only applies to Printers with a Laminator.

ERROR MESSAGE	POSSIBLE CAUSE	POSSIBLE SOLUTION
LAMINATOR EARLY CARD JAM *	Card did not make it to the staging rollers.	Remove the card and/or laminate that is stuck in the laminator staging/cutting area.
LAMINATOR EEPROM DEFAULT *	The parameters stored in EEPROM have been reset to their default values. This will not normally happen, but could be seen with certain FW upgrades when new parameters have been added by Engineering. It could also indicate a problem with the Laminator's EEPROM.	a. Press RETRY on the OCP when this error occurs b. Power cycle the unit.
LAMINATOR FAILED INIT *	A Laminator was detected by the printer, but was unable to communicate to it.	Contact Zebra Technical Support.
LAMINATOR FAN FAIL *	This should only happen if one or both cooling fans fail or the cooling vents near the heated roller assembly are blocked or the fan(s) have failed.	a. Check for blocked vents. b. Contact Zebra Technical Support.
LAMINATOR INITIALIZING *	This warning will be displayed after the laminator door is closed and laminate spools are re-read/detected.	No action needed.
LAMINATOR LATE CARD JAM *	Card did not unblock the exit sensor in the specified time.	a. Check for card jammed in the exit area. b. Assure that the sliding exit door is not partially blocking the exit path.
LAMINATOR MIDDLE CARD JAM *	Card and laminate have jammed inside heater assembly, often due to mis-positioned laminate patch sticking to heated rollers.	Remove the oven, and inspect for stuck cards.
LAMINATOR POLL TIMEOUT *	The laminator expects the printer to periodically send commands to it within a specified time period. If it fails to do so, it assumes that something is wrong with the communication link or that the printer is down. Activation of the PollTimeout fault also results in the laminator being forced into Powersave mode, and operations in progress will be halted. This error may occur if the printer-to-laminator communications is having intermittent problems.	a. Power cycle the printer. b. Contact Zebra Technical Support.
LAMINATOR TOP CUTTER FAIL *	Top cutter has failed.	Contact Zebra Technical Support.
LAMINATOR TOP CUTTER STALL *	Top cutter blade is obstructed, or top cutter mechanism is damaged.	Contact Zebra Technical Support.
LAMINATOR TOP HEATER FAIL *	Top heater did not turn on after being instructed to do so. When the heater is enabled, the controller will wait a certain specified amount of time for it to attain the set target temperature. If the heater fails to reach the target in the specified time, the TopHeaterFail fault will be set.	a. Replace the top halogen bulb. b. Contact Zebra Technical Support.

\* Message only applies to Printers with a Laminator.

ERROR MESSAGE	POSSIBLE CAUSE	POSSIBLE SOLUTION
LAMINATOR TOP TEMP SENSOR FAIL *	The top temperature (thermopile) sensor has failed.	Contact Zebra Technical Support.
LAMINATOR TOP TEMPERATURE HIGH *	If the top roller temperature ever exceeds a fixed temperature threshold, the over temp error occurs.	a. Power cycle the printer. b. Contact Zebra Technical Support.
LAMINATOR UNKNOWN ERROR *	An unknown error has occurred – this is an indication of a FW problem and should not occur.	Press RETRY on the OCP.
LAMINATOR WARMING *	This warning will be cleared when the heaters attain their temperature targets.	No action necessary.
MAG MOTION ERROR	Mag card positioning error encountered.	Retry writing and reading.
MAG READ ERROR	<ul style="list-style-type: none"> <li>• Encoding error.</li> <li>• Defective magnetic stripe.</li> </ul>	a. Ensure that you are using the correct card type. b. Check that the cards are loaded with the magnetic stripe in the correct orientation (normally stripe down and toward the rear of the printer). c. Ensure that the cards are set-up correctly in the printer driver (coercivity setting). d. Ensure that the data conforms to ISO Specifications. e. Retry reading.
MAG WRITE ERROR	<ul style="list-style-type: none"> <li>• Encoding error.</li> <li>• Defective magnetic stripe.</li> </ul>	a. Ensure that you are using the correct card type. b. Check that the cards are loaded with the magnetic stripe in the correct orientation (normally stripe down and toward the rear of the printer). c. Ensure that the cards are set-up correctly in the printer driver (coercivity setting). d. Ensure that the data conforms to ISO Specifications. e. Retry writing.
MISSING HCB	There is a problem with the HCB (Halogen Controller Board).	a. Power cycle the printer. b. Contact Zebra Technical Support.
MISSING LAMINATOR MAG *	An error occurred when trying to communicate to the Laminator MAB (Media Authentication Board).	a. Power cycle the printer. b. Contact Zebra Technical Support.
MISSING MAB	An error occurred when reading the RFID Tag by the MAB (Media Authentication Board).	a. Check print ribbon orientation. b. Verify part number of the print ribbon. c. Power cycle the printer. d. Contact Zebra Technical Support.

\* Message only applies to Printers with a Laminator.













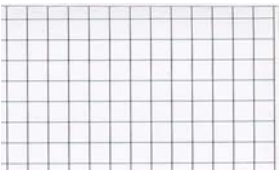

ERROR MESSAGE	POSSIBLE CAUSE	POSSIBLE SOLUTION
MOTOR VOLTAGE ERROR	Incorrect voltage detected at one or several motors in the unit.	a. Power cycle the printer. b. Contact Zebra Technical Support.
NO MAG STRIPE	Mag stripe not detected.	a. Ensure that you are using the correct card type. b. Check that the cards are loaded with the magnetic stripe in the correct orientation (normally stripe down and toward the rear of the printer).
OUT OF CARDS	<ul style="list-style-type: none"> <li>• The Input Hopper is empty.</li> <li>• Card is stuck in Input Hopper.</li> </ul>	a. Load cards into the Input Hopper. b. Re-seat the Input Hopper.
OUT OF FILM	The transfer film has run out.	Load new roll of transfer film.
OUT OF RIBBON	The print ribbon has run out.	Load a new roll of print ribbon.
PRINTHEAD MOTION ERR	Printhead did not move to proper position during initialization.	a. Power cycle the printer. b. Contact Zebra Technical Support.
PRINTHEAD TOO COLD	Printhead temperature out of proper range (COLD).	Turn off power, and contact Zebra Technical Support.
PRINTHEAD TOO HOT	Printhead temperature out of proper range (HOT).	Turn off power, and contact Zebra Technical Support.
REJECT ERROR	A problem during the reject process.	Contact Zebra Technical Support.
RIB COLOR DETECT ERR	Print ribbon is not installed correctly.	Reinstall the print ribbon.
RIBBON ADC ERROR	Possible hardware issue.	Contact Zebra Technical Support.
RIBBON BEMF ERROR	Problem with the Back EMF (BEMF) of the ribbon motors.	Contact Zebra Technical Support.
RIBBON JAM	The print ribbon is jammed.	a. Check the print ribbon. b. Reinstall the print ribbon. c. Repair the break in the print ribbon and reinstall.
RIBBON MOTION ERROR	Ribbon not correctly responding to motion commands.	a. Check the print ribbon. b. Reinstall the print ribbon. c. Repair the break in the print ribbon and reinstall.
ROLLERS OVER TEMP	Heated Rollers (used to transfer the image from the transfer film to the Card) are too hot for proper operation.	Turn off power, and contact Zebra Technical Support.
ROLLERS UNDER TEMP	Heated Rollers (used to transfer the image from transfer film to Card) are not hot enough for proper operation.	Turn off power, and contact Zebra Technical Support.

ERROR MESSAGE	POSSIBLE CAUSE	POSSIBLE SOLUTION
SMARTCARD POS ERROR	<ul style="list-style-type: none"> <li>Faulty card.</li> <li>Incorrect card orientation.</li> <li>Card feed error.</li> <li>Mechanical alignment issue.</li> </ul>	<ul style="list-style-type: none"> <li>Try another card.</li> <li>Try another card (check orientation).</li> <li>Check card path.</li> <li>Contact Zebra Technical Support.</li> </ul>
SYSTEM ERROR	Internal logic error.	<ol style="list-style-type: none"> <li>Power cycle the printer.</li> <li>Contact Zebra Technical Support.</li> </ol>
SYSTEM NOT READY	A problem was detected during printer start-up.	<ol style="list-style-type: none"> <li>Power cycle the printer.</li> <li>Contact Zebra Technical Support.</li> </ol>
TOP LAMINATE FEED *	<ul style="list-style-type: none"> <li>Top laminate cartridge is not installed properly.</li> <li>Cartridge is not removed when that side of the card is not being laminated.</li> <li>A mis-cut piece of laminate (rare) is obscuring the media sensor.</li> </ul>	<ul style="list-style-type: none"> <li>Remove, reposition, and re-install the top laminate cartridge.</li> <li>Remove the top laminate cartridge.</li> <li>Remove the mis-cut piece of laminate.</li> </ul>
TOP LAMINATE OUT *	The top laminate has run out.	Load new roll of laminate.
TOP LAMINATE REGISTRATION *	<ul style="list-style-type: none"> <li>Improperly prepared registered laminate.</li> <li>Media misfeed.</li> <li>Patch length improperly set.</li> </ul> <p>Unexpected end of laminate roll detected.</p>	Remove and recut laminate in the center of the index notch, re-install, and retry.
TRANSFER ERROR	A problem was detected during the transfer process (print ribbon to film).	Contact Zebra Technical Support.

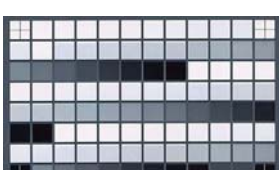
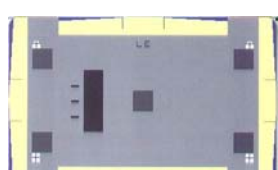

\* Message only applies to Printers with a Laminator.

# OCP Test Card Images

See detailed Test Card descriptions on the following page.

		
Mid Gray	Grid On Gray	Cyan Stripes
		
2 Pixel Grid	Mid Magenta	Dark Cyan
		
Max Gray	Offset Dots	Smear
		
Min Magenta	White Max-Gray	Max-Gray White
		
Motion & Registration	Gradient Boxes	Density Setup
		
Grid On Gray 2		

## Test Card Descriptions

	Image	Description	Print artifacts to look for with this image
	Mid Gray	Flat uniform gray	Motion artifacts, banding, platen defects, transfer artifacts, dirt, overall density level
	Grid On Gray	Solid black on top, gray grid underneath	Colored ribbon wrinkles in the black area, or clear/white transfer film wrinkles in the gray area
	Cyan Stripes	Horizontal cyan stripes alongside vertical lighter cyan box	Non-uniformity or horizontal banding within cyan box on right of card
	2 Pixel Grid	2 pixel wide grid lines on white	Mis-registration between color planes
	Mid Magenta	Flat uniform mid-density magenta	Motion artifacts, banding, platen defects, density level, uniformity
	Dark Cyan	Maximum cyan only density image	Motion artifacts, transfer artifacts, scratches, dirt
	Max Gray	Maximum CMY (black) density image	Wrinkles, snapping noise during printing, ribbon / transfer-film tears or breaks, flash, card positioning
	Offset Dots	Individual C, M, and Y dots spaced at regular intervals	Motion artifacts on specific color planes, mis-registration
	Smear	Gray with full density YMCK blocks near top	Color smear artifacts
	Min Magenta	Flat uniform low-density magenta	Motion artifacts, banding, platen defects, density level, uniformity, bead position
	White Max-Gray	Max-density areas on sides with tilted white center	Ribbon wrinkle
	Max-Gray White	Same as above with slant direction changed	Ribbon wrinkle
	Motion & Registration	Uniform cyan with registration marks on sides	Banding, mis-registrations, motion artifacts
	Gradient Boxes	3 sets of light-to-dark grayscale ramps	Used to create color calibration look-up table
	Density Setup	Used to measure mid and max densities	Density level of mid-gray and black
	Grid On Gray 2	Less stressful version of the grid-on-gray target	Colored ribbon wrinkles in the black area, or clear/white transfer film wrinkles in the gray area



## Ethernet Issues

If both LEDs are off, the printer has not detected the presence of a network cable. To solve the problem:

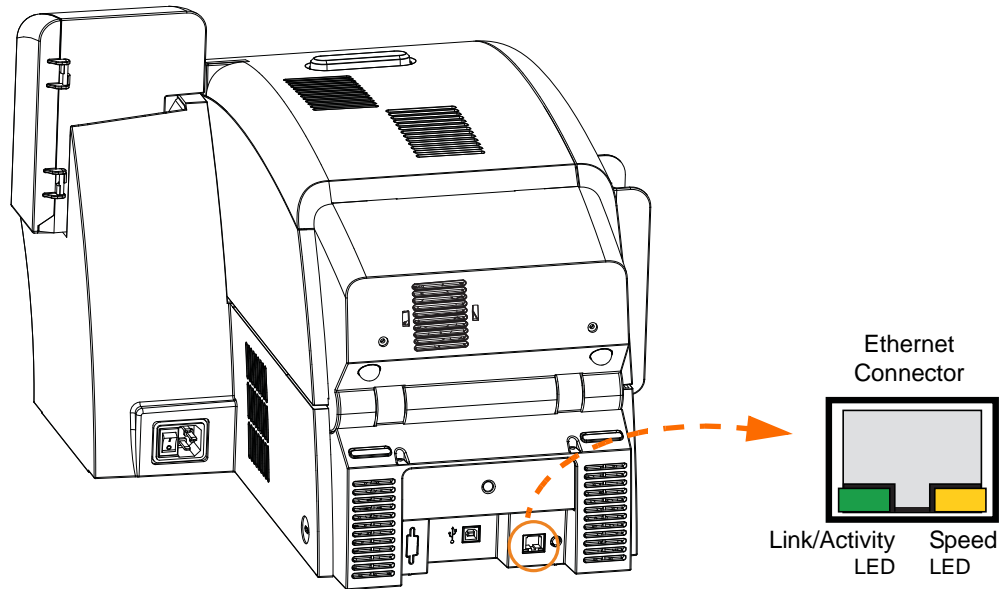

- Verify that the network cable is appropriate and has an RJ-45 connector.
- Remove the network cable from the printer. Plug the network cable back in until you hear a positive click. Check the other end of the cable in the same manner. If the printer still does not detect a cable, then continue.
- Connect the printer to a known good network. If the printer is still unable to detect the network cable, contact Technical Support for assistance.

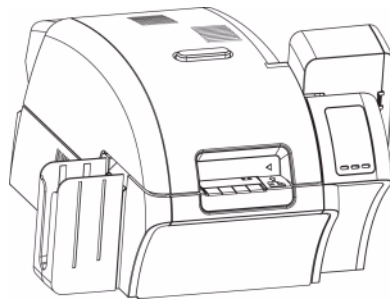



# Technical Specifications

## Standard Features

- Thermal transfer and dye diffusion to transfer film
- Full color or monochrome reverse transfer printing
- Single- and dual-sided printing
- Maximum print speed (batch mode; i.e., the same image repeatedly)
  - Single-sided (Front Only)
 

YMC	190 cph
YMCK	160 cph
  - Dual-sided (Front and Back)
 

YMCK (YMC Front, K Back)	170 cph
YMCKK (YMCK Front, K Back)	150 cph
- Photo quality image
- Over-the-edge printing on standard CR80 media
- Microsoft Windows Certified drivers
- Single-card feed capability
- 150 card capacity feeder (30 mil)
- 15 card reject hopper (30 mil)
- 100 card output hopper (30 mil)
- i Series™ intelligent media technology
- Auto calibration of media
- 21-character soft menu LCD text operator display
- 304 dpi (12.0 dots/mm) print resolution
- 64MB memory standard
- 2-year unlimited warranty on printer, lifetime limited warranty on printhead with Genuine Zebra Supplies

## Specifications

### Encoding Options

- Smart card contact encoder – ISO 7816, PC/SC Compliant
- Magnetic stripe encoder – ISO 7811 and JIS-II (new and re-encoded; tracks 1, 2, and 3; high and low coercivity; stripe down; 30 - 40 mil card thickness)
- Contact smart card encoder – EMV level 1 certified
- ISO 14443 MIFARE (13.56 MHz) and ISO 7816 contact encoder combo

### Communications Interfaces

- USB V2.0 / 1.1 protocol
- USB supports plug-n-play printer identification
- USB and internal 10/100 Ethernet (Standard)

### Software

#### Microsoft Windows Certified Printer Drivers Supported

- Windows XP\*, Windows Vista\*, Windows 7\*, Windows Server 2003\*
- \*32-bit and 64-bit certified

#### Driver Features

- Graphical card orientation setting to visualize card printing setup and configuration
- Card type setting eliminates unnecessary setup and configuration settings
- Complete graphical control over area and element selection of black extraction parameters insures true black and color printing exactly where you want it on the card
- Auto sensing of print ribbon type
- Optional driver password protection setting to prevent accidental or unauthorized printer configuration changes

#### ZXP Toolbox

- Printer configuration tools and utilities for complete control over all printer functions and features
- User role-based features enables true security printer operations
- Complete technology card management enables setup and testing of all printer and encoder features and functionality
- Printer test cards and diagnostics utilities ensure error free printing and fast troubleshooting capabilities

## Card Compatibility

- Card Thickness: 30 – 40 mil
- Card Size: ISO 7810 format, Type ID-1, CR-80
- Card Material: ABS; PVC, Composite; TESLIN, Composite; PET; PETG; Polycarbonate; PVC

## Agency Approvals

Zebra ZXP Series 8 Card Printer complies with following applicable directives and standards for the ITE: Residential, Commercial & Light Industry environments

- For US/Canada/Mexico/Australia&NZ
  - FCC Class A, cfr47, Part 15 Subpart J
  - FCC 15.257 2008, Part15 Subpart C
  - Canadian STD RSS-210
  - NOM-ETL (Mexico)
  - EN60950: 2000 Safety Standard (TUV & RTL)
  - C-Tick (Australia) Electromagnetic Radiation Standard
- For Europe:
  - Applicable Directives and Supporting Standards:

2004/108/EC EMC Directive, EN55022:2006 Class A,  
EN55024:1998+AD1:2001+AD2:2003,  
EN61000-3-2:2006, EN61000-3-3:1995+AD1:2001,  
2006/95/EC LVD Directive, EN60950-1:2001, CB Scheme
  - WLAN Enabled

Applicable Directives and Supporting Standards:  
99/5/EC R&TTE Directive, EN 301 489-17 V1.2.1 (2002-08),  
EN 300 328 V1.7.1 (2006-10)
  - RFID Enabled

Applicable Directives and Supporting Standards:  
99/5/EC R&TTE Directive, EN 301 489-3 V1.4.1 (2002-08),  
EN 300 220-2 V2.1.2 (2007-06)

## Electrical

- Auto-switching Single-phase AC power
- 90V~264V AC RMS and 47-63 HZ (50-60 Hz nominal)
- Power consumption:

Idle	100 W
Printing	150 W
Initializing / Warm-up	300 W
Sleep	20 W

## Physical

- Height (printer only) 11.9" (303 mm)
- Height (with card feeder) 13.2" (336 mm)
- Width 14" (356 mm)
- Width (with card feeder) 14.9" (379 mm)
- Depth 20.4" (519 mm)
- Weight (printer only) 27.5 lbs (12.5 kg)

## Environmental

- Operating Temperature 59° to 77°F (15° to 25°C)
- Storage Temperature 23° to 131°F (-5° to 55°C)
- Operating Humidity 20% to 80% non-condensing
- Storage Humidity 10% to 90% non-condensing
- Shipping Temperature -40° to 140°F (-40° to 60°C)
- Shipping Humidity 10 to 90% non-condensing

## Declarations of Conformity



---

### ZEBRA TECHNOLOGIES CORPORATION

Declares that the following Information Technology Equipment

#### Zebra ZXP Series 8 Card Printer

complies with following applicable directives and standards for the  
ITE: Residential, Commercial & Light Industry environments

#### Applicable Directives and Supporting Standards:

2004/108/EC EMC Directive, EN55022:2006 Class A,  
EN55024:1998+AD1:2001+AD2:2003EN, 61000-3-2:2006, EN61000-3-3:1995+AD1:2001,  
2006/95/EC LVD Directive, EN60950-1:2001, CB Scheme

#### RFID Enabled

Applicable Directives and Supporting Standards:  
99/5/EC R&TTE Directive, EN 301 489-3 V1.4.1 (2002-08), EN 300 220-2 V2.1.2 (2007-06)

---

For a formal certificate, please contact the Compliance Office at Zebra's Camarillo facility.

**EUROPE:** Norway Only: This product is also designed for IT power system with phase to phase voltage 230V. Earth grounding is via the polarized, 3-wire power cord.

FI: "Laitte on liitettävä suojamaadoitus koskettimilla varustettuun pistorasiaan"

SE: "Apparaten skall anslutas till jordat uttag"

NO: "Apparatet må tilkoples jordet stikkontakt"

### FCC Regulations

The Zebra ZXP Series 8 Card Printer has been tested and found to comply with the limits for a Class A digital device, pursuant to Part 15 of the FCC Rules. These limits are designed to provide reasonable protection against harmful interference when the equipment is operated in a commercial environment. This equipment generates, uses, and can radiate radio frequency energy and, if not installed and operated in accordance with the Zebra ZXP Series 8 Card Printer User's Manual, may cause harmful interference to radio communications. Operation of this equipment in a residential area is likely to cause harmful interference in which case the user will be required to correct the interference at his own expense.

Pursuant to Part 15.21 of the FCC Rules, any changes or modifications to this equipment not expressly approved by Zebra may cause harmful interference and void the FCC authorization to operate this equipment.

### FCC Radiation Exposure Statement (applicable to 15.247 device only)

This equipment complies with FCC radiation exposure limits set forth for an uncontrolled environment. This equipment should be installed and operated with minimum 20 cm between the radiator and your body. This transmitter must not be collocated or operating in conjunction with any other antenna or transmitter unless authorized to do so by the FCC.

### Industry Canada Notice

This device complies with Industry Canada ICES-003 class A requirements.  
Cet équipement est conforme à l'ICES-003 classe A de la Norme Industrielle Canadienne.

## **Japan: Ministry of Internal Affairs and Communications (MIC) Certification**

This product has received MIC approval.

Approval number is No. AC-xxxxx

This equipment generates, uses, and can radiate radio frequency energy and, if not installed and operated in accordance with the User's Manual, may cause harmful interference to radio communications or medical instruments such as a pacemaker.



# *APPENDIX A*

---

## Printer Configurations



### **Introduction**

The Part Number of a particular printer is shown on a label affixed to the bottom of the printer; that Part Number identifies the specific configuration for that printer. The chart on the following page shows the configurations that are available.

## Part Numbers

PART NUMBER	DESCRIPTION
Z 8 _	<b>Base Unit</b>
_ _ 1 - _ _ _ _ _ _ _ _ _ _ _ _ 2 - _ _ _ _ _ _ _ _ _ _	Single-Sided Printing Dual-Sided Printing
_ _ _ - 0 _ _ _ _ _ _ _ _ _ _ _ _ _ - A _ _ _ _ _ _ _ _ _ _ _ _ _ - E _ _ _ _ _ _ _ _ _ _	<b>Smart Card Options</b> None Contact Encoder + Contactless MIFARE Contact Station
_ _ _ - 0 _ _ _ _ _ _ _ _ _ _ _ _ _ - M _ _ _ _ _ _ _ _ _ _	<b>Mag Encoders</b> None ISO HiCo/LoCo Mag S/W Selectable
_ _ _ - 0 _ _ _ _ _ _ _ _ _ _ _ _ _ - A _ _ _ _ _ _ _ _ _ _	<b>Security Options</b> None Enclosure Lock
_ _ _ - C _ _ _ _ _ _ _ _ _ _	<b>Interface</b> USB and 10/100 Ethernet
_ _ _ - 0 _ _ _ _ _ _ _ _ _ _ _ _ _ - D _ _ _ _ _ _ _ _ _ _	<b>Software/Kit</b> None Media Starter Kit (includes: 1 YMCK ribbon kit, 1 roll of InTM, 200 PVC cards)
_ _ _ - 0 0 0 _ _ _ _ _ _ _ _ _ _ - 0 0 A _ _ _ _ _ _ _	<b>Miscellaneous</b> None Made in America
_ _ _ - _ _ _ _ _ _ _ _ 0 0 _ _	<b>Custom Code</b> Reserved for future options
_ _ _ - _ _ _ _ _ _ _ _ 0 0	<b>Custom Code</b> Reserved for future options

# Appendix B

## Setting Custom Card Specifications



### B.1 Introduction

This document is to be used for setting the specifications for cards not listed in the **Card type in use** dropdown menu; circled below. Setting the specifications for a non-listed card type is a three-step process that uses the Card Setup Tab:



**Note** • To access the Card Setup Tab, select *Start > Printers and Faxes*. Right click on the *Zebra ZXP Series 8 Card Printer* listing; and select *Printing Preferences > Card Setup*.

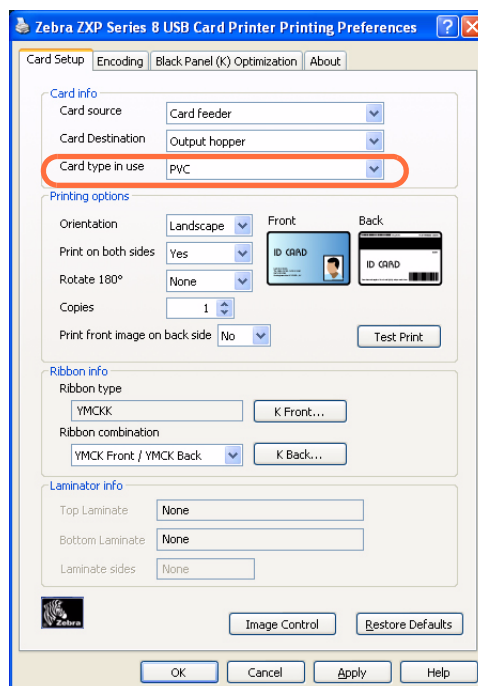

## B.2 Process Flowchart

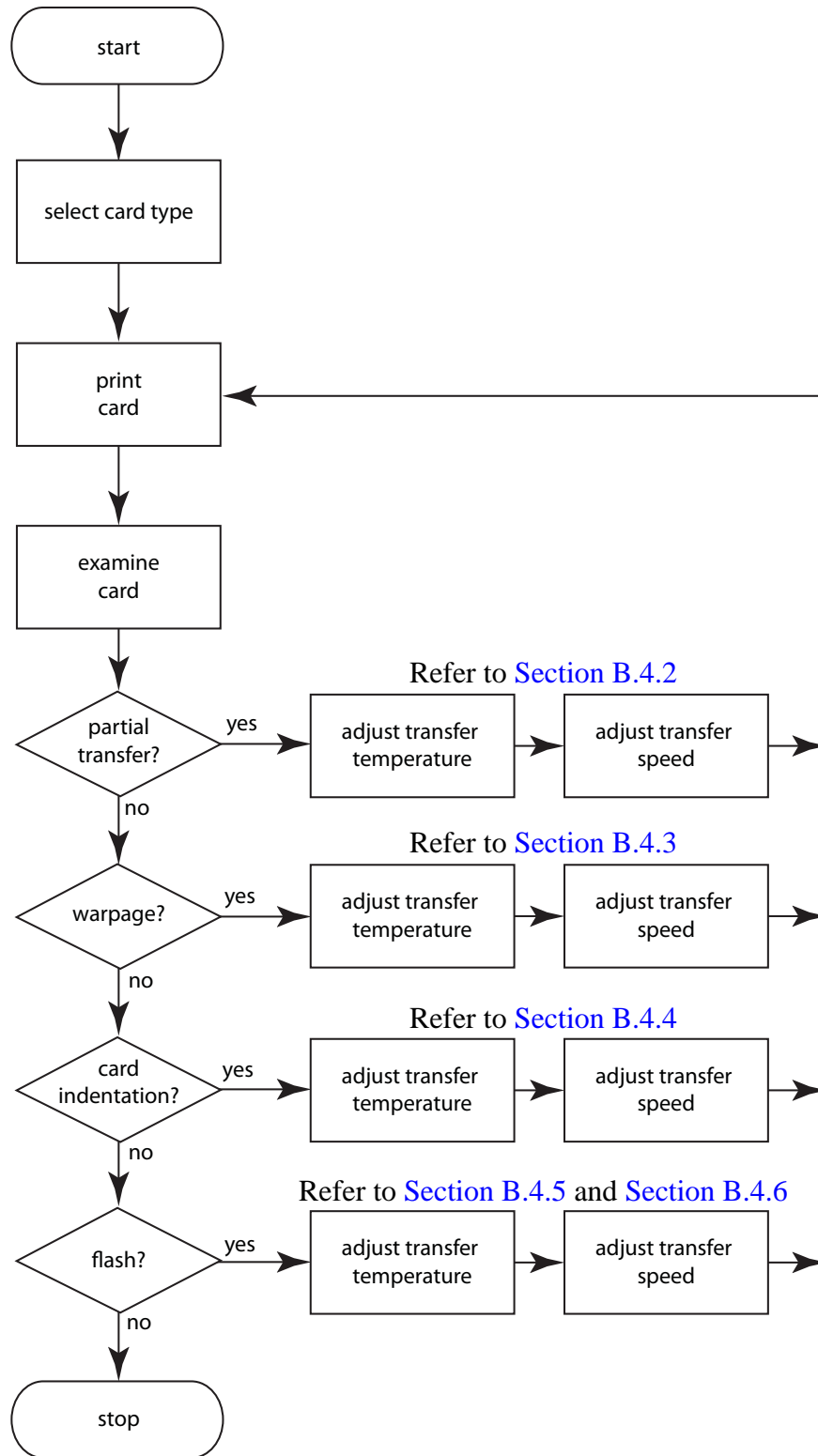

## B.3 3-Step Process

### Step 1: Select the Card Type

From the **Card type in use** dropdown menu, select *Custom 1* or *Custom 2*; and click OK. Note that *Custom 1* or *Custom 2* have adjustable transfer temperature and transfer speed tables; the other card types do not.

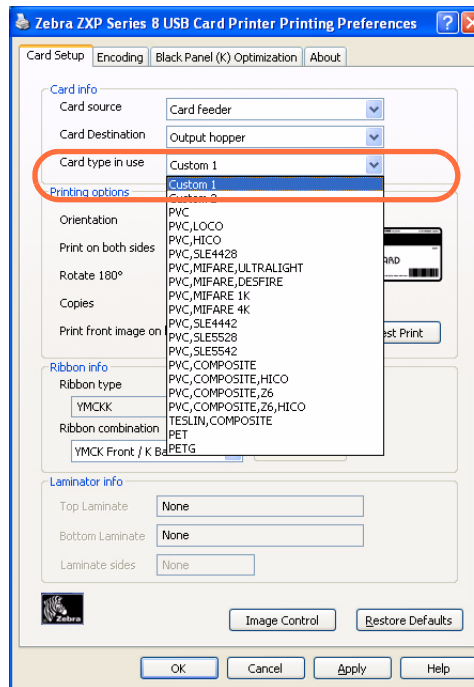

## Step 2: Make adjustments



**Note** • Before making any adjustments, print and examine a test card ([Step 3:](#)). The quality of the test card will determine whether or not to continue the process.

After selecting *Custom 1* or *Custom 2*, the Card Specifications window will appear. Make the recommended transfer temperature and/or transfer speed adjustment ([Section B.4](#)), and click OK.

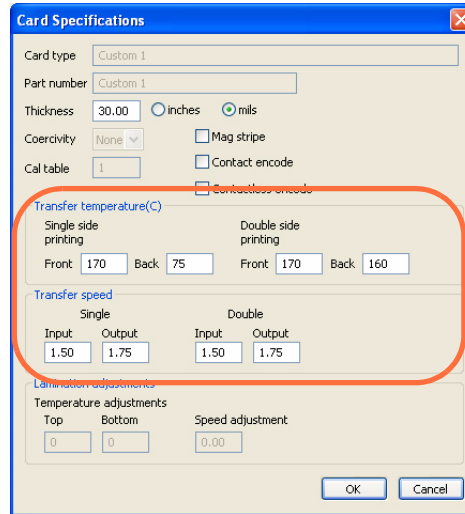

The Card Specifications window will close.

### Step 3: Print and examine Test Card

From the Card Setup tab, print (click on the **Test Print** button circled below) and examine a test card.

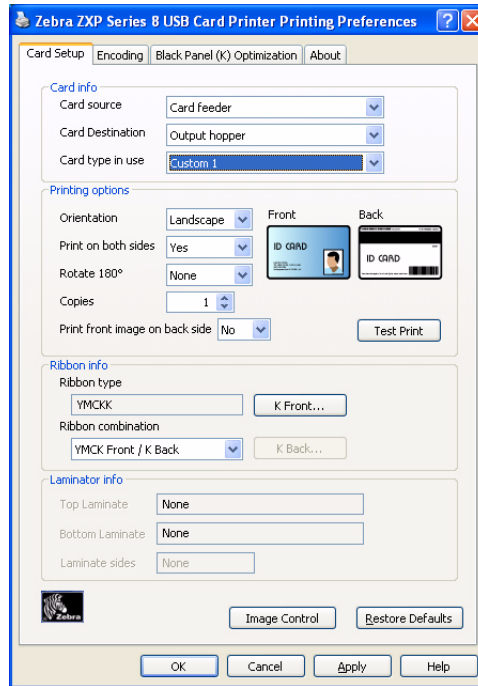

The quality of the test card will determine whether or not to continue the process.

## B.4 Adjustments

Problems addressed in this section include:

<b>B.4.2 Partial Transfer</b> .....	126
Front of card .....	126
Back of card .....	129
<b>B.4.3 Warpage</b> .....	132
Edges curled down .....	132
Edges curled up .....	135
Irregular Warpage .....	138
<b>B.4.4 Card Indentation</b> .....	142
<b>B.4.5 Flash</b> .....	146
Side Edge .....	146
Leading Edge .....	149
<b>B.4.6 Special Cases</b> .....	151
Flash on Smart Card Chip .....	151
Flash on Magnetic Stripe .....	155
Excess Leading-Edge Flash on Mag Cards .....	159



## B.4.1 Adjustment Overview

When making adjustments, be aware that interdependencies exist between parameters; e.g., to fix the upward warpage, the first step is to decrease the front side transfer temperatures; but this could affect the partial transfer and possibly the flash.

To compensate for interdependency issues, adjust the parameters in the following order:

- Step 1.** Start by correcting any partial transfer issues using the same procedure outlined in [Section B.4.2](#).
- Step 2.** Then attempt to improve warpage ([Section B.4.3](#)) and indentations ([Section B.4.4](#)). Start with the acceptable settings from [Step 1](#). While adjusting parameters, ensure that the transfer quality remains acceptable. Do not continue reducing temperatures or increasing speeds if the transfer quality becomes unacceptable.
- Step 3.** Then attempt to improve flash ([Section B.4.5](#)). Start with the acceptable settings from [Step 2](#). While adjusting parameters, ensure transfer *and* warpage remain acceptable.

## B.4.2 Partial Transfer



Light or missing transfer on the sides

Spotty transfer anywhere on the card

Light transfer on entire card

### Front of card

Partial transfer is usually caused by lack of energy being transferred to the card, i.e. the temperatures are too low or the speeds are too fast.

**Step 1.** Increase Front Transfer Temperature:

- a. From the Card Specifications window, make a note of the default front transfer temperature settings; see [Section B.3](#).
- b. Increase the appropriate (single or double side) front transfer temperature by 5.
- c. Click on the **OK** button.

Transfer temperature(C)			
Single side printing		Double side printing	
Front	175	Back	75
Front	170	Back	160

- d. Print a test card; see [Section B.3](#).
- e. Examine the test card.
  - If there is noticeable improvement, continue increasing the front transfer temperature by 5, printing a test card, and examining the resulting card. Stop when the problem is corrected or there is no more improvement. If the problem is corrected, no more adjustment is required; otherwise go to [Step 2](#).
  - If there is no noticeable improvement, return the temperature to its default setting; and go to [Step 2](#).

**Step 2.** Decrease Transfer Input Speed

- a. From the Card Specifications window, make a note of the default transfer input speed settings.
- b. Decrease the appropriate (single or double) transfer input speed by 0.2.
- c. Click on the **OK** button.

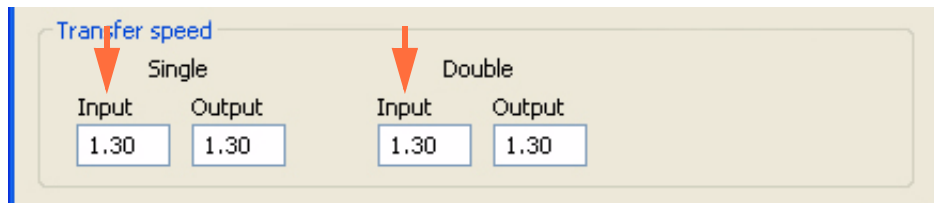

- d. Print a test card.
- e. Examine the test card.
  - If there is noticeable improvement, continue decreasing the transfer input speed by 0.2, printing a test card, and examining the resulting card. Stop when the problem is corrected or there is no more improvement. If the problem is corrected, no more adjustment is required; otherwise go to [Step 3](#).
  - If there is no noticeable improvement, return the speed to its default setting; and go to [Step 3](#).

## Setting Custom Card Specifications

### Adjustments

#### Step 3. Decrease Transfer Output Speed

- a. From the Card Specifications window, make a note of the default transfer output speed settings.
- b. Decrease the appropriate (single or double) transfer output speed by 0.2.
- c. Click on the **OK** button.

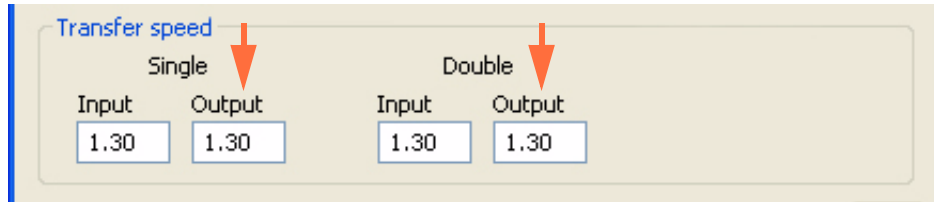

- d. Print a test card.
- e. Examine the test card.
  - If there is noticeable improvement, continue decreasing the transfer output speed by 0.2, printing a test card, and examining the resulting card. Stop when the problem is corrected or there is no more improvement. If the problem is corrected, no more adjustment is required. If the problem persists, contact Zebra Technical Support.
  - If there is no noticeable improvement, return the transfer output speed to its default setting; and contact Zebra Technical Support.

## Back of card

Partial transfer is usually caused by lack of energy being transferred to the card, i.e. the temperatures are too low or the speeds are too fast.

### Step 1. Increase Back Transfer Temperature:

- a. From the Card Specifications window, make a note of the default back transfer temperature settings; see [Section B.3](#).
- b. Increase the appropriate (single or double side) back transfer temperature by 5.
- c. Click on the **OK** button.

The screenshot shows a window titled "Transfer temperature(C)". It contains two sections: "Single side printing" and "Double side printing". Each section has two input fields: "Front" and "Back". In the "Single side printing" section, the "Front" field contains the value 175 and the "Back" field contains the value 75. In the "Double side printing" section, the "Front" field contains the value 170 and the "Back" field contains the value 160. Red arrows point to the "Back" input fields in both sections, indicating the target for adjustment.

Printing Type	Side	Temperature (C)
Single side printing	Front	175
	Back	75
Double side printing	Front	170
	Back	160

- d. Print a test card; see [Section B.3](#).
- e. Examine the test card.
  - If there is noticeable improvement, continue increasing the back transfer temperature by 5, printing a test card, and examining the resulting card. Stop when the problem is corrected or there is no more improvement. If the problem is corrected, no more adjustment is required; otherwise go to [Step 2](#).
  - If there is no noticeable improvement, return the temperature to its default setting; and go to [Step 2](#).

## Setting Custom Card Specifications

### Adjustments

#### Step 2. Decrease Transfer Input Speed

- a. From the Card Specifications window, make a note of the default transfer input speed settings.
- b. Decrease the appropriate (single or double) transfer input speed by 0.2.
- c. Click on the **OK** button.

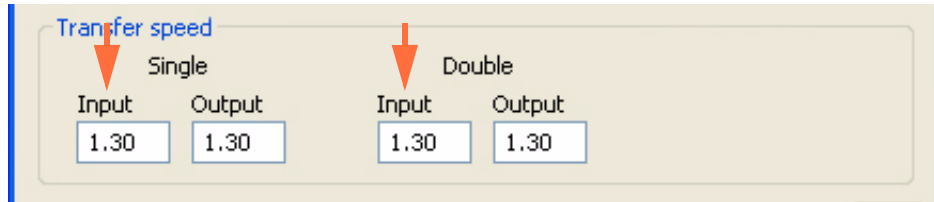

- d. Print a test card.
- e. Examine the test card.
  - If there is noticeable improvement, continue decreasing the transfer input speed by 0.2, printing a test card, and examining the resulting card. Stop when the problem is corrected or there is no more improvement. If the problem is corrected, no more adjustment is required; otherwise go to [Step 3](#).
  - If there is no noticeable improvement, return the speed to its default setting; and go to [Step 3](#).

**Step 3.** Decrease Transfer Output Speed

- a. From the Card Specifications window, make a note of the default transfer output speed settings.
- b. Decrease the appropriate (single or double) transfer output speed by 0.2.
- c. Click on the **OK** button.

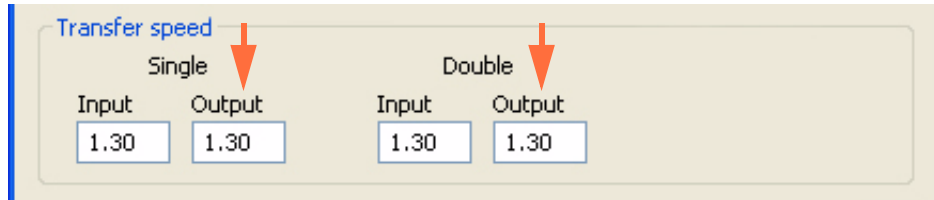

- d. Print a test card.
- e. Examine the test card.
  - If there is noticeable improvement, continue decreasing the transfer output speed by 0.2, printing a test card, and examining the resulting card. Stop when the problem is corrected or there is no more improvement. If the problem is corrected, no more adjustment is required. If the problem persists, contact Zebra Technical Support.
  - If there is no noticeable improvement, return the transfer output speed to its default setting; and contact Zebra Technical Support.

## B.4.3 Warpage

### Edges curled down

Warpage is usually caused by too much energy being transferred to the card; i.e., the temperatures are too hot or the speeds are too slow.

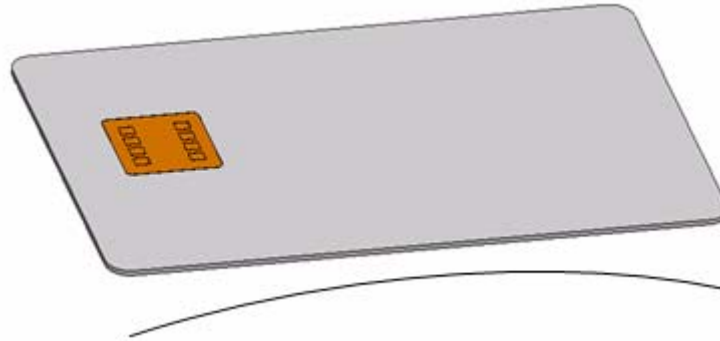

#### Step 1. Decrease Back Transfer Temperature:

- a. Go to the Card Specifications window; see [Section B.3](#).
- b. Make a note of the default back transfer temperature settings.
- c. Decrease the appropriate (single or double side) back transfer temperature by 5.
- d. Click on the **OK** button.

Transfer temperature(C)			
Single side printing			
Front	175	Back	75
Double side printing			
Front	170	Back	160

- e. Print a test card; see [Section B.3](#).
- f. Examine the test card.
  - If there is noticeable improvement, continue decreasing the back transfer temperature by 5, printing a test card, and examining the resulting card. Stop when the problem is corrected or there is no more improvement. If the problem is corrected, no more adjustment is required; otherwise go to [Step 2](#).
  - If there is no noticeable improvement, return the temperature to its default setting; and go to [Step 2](#).



**Step 2.** Increase Front Transfer Temperature:

- a. From the Card Specifications window, make a note of the default front transfer temperature settings.
- b. Increase the appropriate (single or double side) front transfer temperature by 5.
- c. Click on the **OK** button.

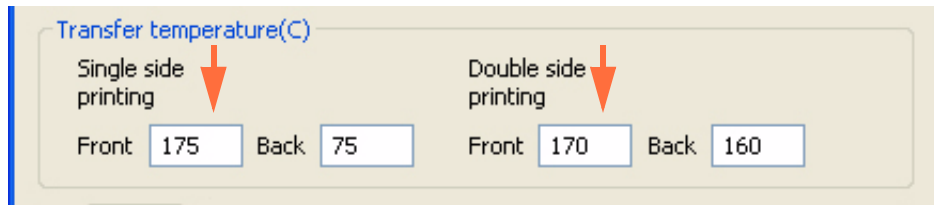

- d. Print a test card.
- e. Examine the test card.
  - If there is noticeable improvement, continue increasing the front transfer temperature by 5, printing a test card, and examining the resulting card. Stop when the problem is corrected or there is no more improvement. If the problem is corrected, no more adjustment is required; otherwise go to [Step 3](#).
  - If there is no noticeable improvement, return the temperature to its default setting; and go to [Step 3](#).

## Setting Custom Card Specifications Adjustments

### Step 3. Increase Transfer Output Speed

- a. From the Card Specifications window, make a note of the default transfer output speed settings.
- b. Increase the appropriate (single or double) transfer output speed by 0.2.
- c. Click on the **OK** button.

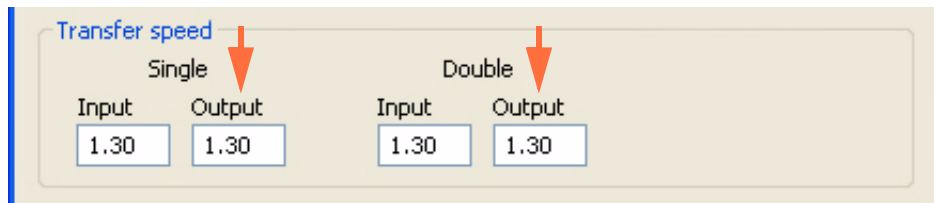

- d. Print a test card.
- e. Examine the test card.
  - If there is noticeable improvement, continue increasing the transfer output speed by 0.2, printing a test card, and examining the resulting card. Stop when the problem is corrected or there is no more improvement. If the problem is corrected, no more adjustment is required. If the problem persists, contact Zebra Technical Support.
  - If there is no noticeable improvement, return the transfer output speed to its default setting; and contact Zebra Technical Support.

## Edges curled up

Warpage is usually caused by too much energy being transferred to the card, i.e. the temperatures are too hot or the speeds are too slow.

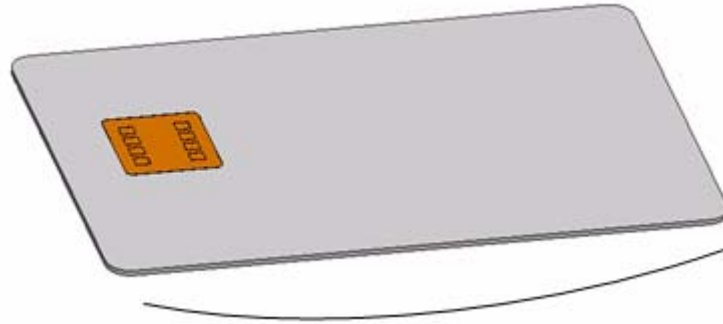

### Step 1. Decrease Front Transfer Temperature:

- a. Go to the Card Specifications window; see [Section B.3](#).
- b. Make a note of the default front transfer temperature settings.
- c. Decrease the appropriate (single or double side) front transfer temperature by 5.
- d. Click on the **OK** button.

Transfer temperature(C)			
Single side printing	↓	Double side printing	↓
Front	<input type="text" value="175"/>	Back	<input type="text" value="75"/>
Front	<input type="text" value="170"/>	Back	<input type="text" value="160"/>

- e. Print a test card; see [Section B.3](#).
- f. Examine the test card.
  - If there is noticeable improvement, continue decreasing the front transfer temperature by 5, printing a test card, and examining the resulting card. Stop when the problem is corrected or there is no more improvement. If the problem is corrected, no more adjustment is required; otherwise go to [Step 2](#).
  - If there is no noticeable improvement, return the temperature to its default setting; and go to [Step 2](#).

## Setting Custom Card Specifications

### Adjustments

#### Step 2. Increase Back Transfer Temperature:

- a. From the Card Specifications window, make a note of the default back transfer temperature settings.
- b. Increase the appropriate (single or double side) back transfer temperature by 5.
- c. Click on the **OK** button.

Single side printing		Double side printing	
Front	175	Front	170
Back	75	Back	160

- d. Print a test card.
- e. Examine the test card.
  - If there is noticeable improvement, continue increasing the back transfer temperature by 5, printing a test card, and examining the resulting card. Stop when the problem is corrected or there is no more improvement. If the problem is corrected, no more adjustment is required; otherwise go to [Step 3](#).
  - If there is no noticeable improvement, return the temperature to its default setting; and go to [Step 3](#).

**Step 3.** Increase Transfer Output Speed

- a. From the Card Specifications window, make a note of the default transfer output speed settings.
- b. Increase the appropriate (single or double) transfer output speed by 0.2.
- c. Click on the **OK** button.

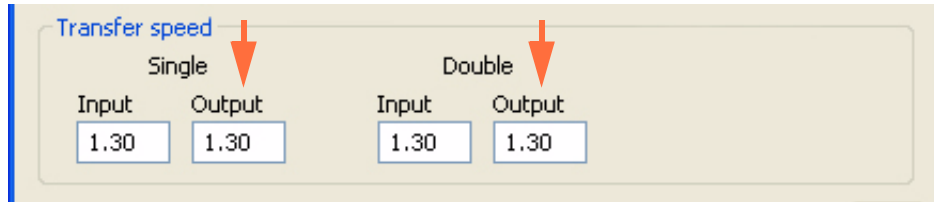

- d. Print a test card.
- e. Examine the test card.
  - If there is noticeable improvement, continue increasing the transfer output speed by 0.2, printing a test card, and examining the resulting card. Stop when the problem is corrected or there is no more improvement. If the problem is corrected, no more adjustment is required. If the problem persists, contact Zebra Technical Support.
  - If there is no noticeable improvement, return the transfer output speed to its default setting; and contact Zebra Technical Support.

## Irregular Warpage



**Note** • Irregular warpage is more common with Smart Cards.

Warpage is usually caused by too much energy being transferred to the card, i.e. the temperatures are too hot or the speeds are too slow.

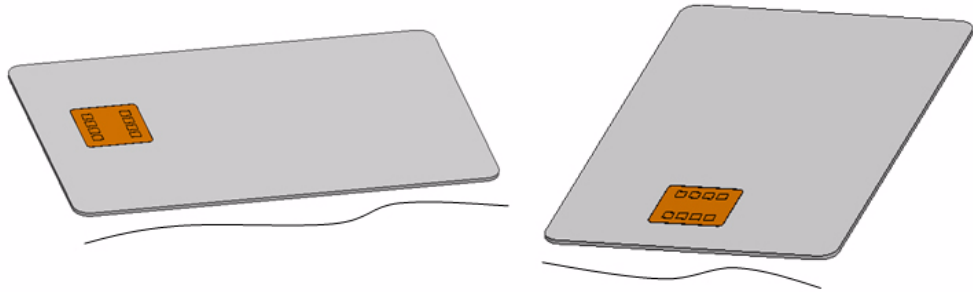

**Step 1.** Decrease Front Transfer Temperature:

- a. Go to the Card Specifications window; see [Section B.3](#).
- b. Make a note of the default front transfer temperature settings.
- c. Decrease the appropriate (single or double side) front transfer temperature by 5.
- d. Click on the **OK** button.

Transfer temperature(C)

Printing Type	Front (C)	Back (C)
Single side printing	175	75
Double side printing	170	160

Red arrows point to the Front temperature values for both single and double side printing.

- e. Print a test card; see [Section B.3](#).
- f. Examine the test card.
  - If there is noticeable improvement, continue decreasing the front transfer temperature by 5, printing a test card, and examining the resulting card. Stop when the problem is corrected or there is no more improvement. If the problem is corrected, no more adjustment is required; otherwise go to [Step 2](#).
  - If there is no noticeable improvement, return the temperature to its default setting; and go to [Step 2](#).

**Step 2.** Decrease Back Transfer Temperature:

- a. Go to the Card Specifications window.
- b. Make a note of the default back transfer temperature settings.
- c. Decrease the appropriate (single or double side) back transfer temperature by 5.
- d. Click on the **OK** button.

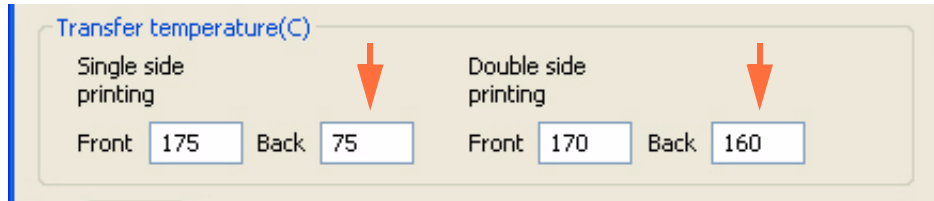

- e. Print a test card.
- f. Examine the test card.
  - If there is noticeable improvement, continue decreasing the back transfer temperature by 5, printing a test card, and examining the resulting card. Stop when the problem is corrected or there is no more improvement. If the problem is corrected, no more adjustment is required; otherwise go to [Step 3](#).
  - If there is no noticeable improvement, return the temperature to its default setting; and go to [Step 3](#).

## Setting Custom Card Specifications

### Adjustments

#### Step 3. Increase Transfer Output Speed

- a. From the Card Specifications window, make a note of the default transfer output speed settings.
- b. Increase the appropriate (single or double) transfer output speed by 0.2.
- c. Click on the **OK** button.

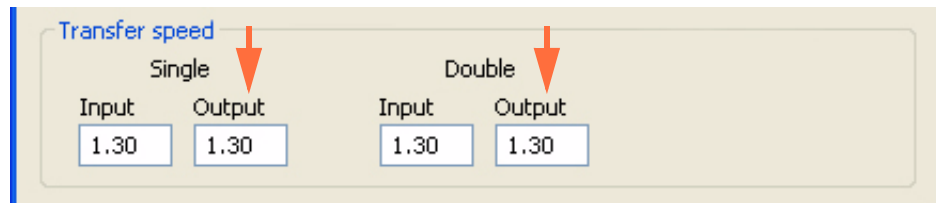

- d. Print a test card.
- e. Examine the test card.
  - If there is noticeable improvement, continue increasing the transfer output speed by 0.2, printing a test card, and examining the resulting card. Stop when the problem is corrected or there is no more improvement. If the problem is corrected, no more adjustment is required; otherwise go to [Step 4](#).
  - If there is no noticeable improvement, return the transfer output speed to its default setting; and go to [Step 4](#).



**Step 4.** Increase Transfer Input Speed

- a. From the Card Specifications window, make a note of the default transfer input speed settings.
- b. Increase the appropriate (single or double) transfer input speed by 0.2.
- c. Click on the **OK** button.

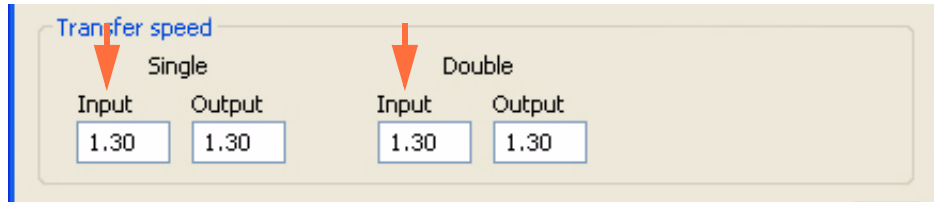

- d. Print a test card.
- e. Examine the test card.
  - If there is noticeable improvement, continue increasing the transfer input speed by 0.2, printing a test card, and examining the resulting card. Stop when the problem is corrected or there is no more improvement. If the problem is corrected, no more adjustment is required. If the problem persists, contact Zebra Technical Support.
  - If there is no noticeable improvement, return the transfer input speed to its default setting; and contact Zebra Technical Support.

## B.4.4 Card Indentation

Indentations are usually caused by too much energy being transferred to the card, i.e. the temperatures are too hot or the speeds are too slow.



### Step 1. Decrease Front Transfer Temperature:

- a. Go to the Card Specifications window; see [Section B.3](#).
- b. Make a note of the default front transfer temperature settings.
- c. Decrease the appropriate (single or double side) front transfer temperature by 5.
- d. Click on the **OK** button.

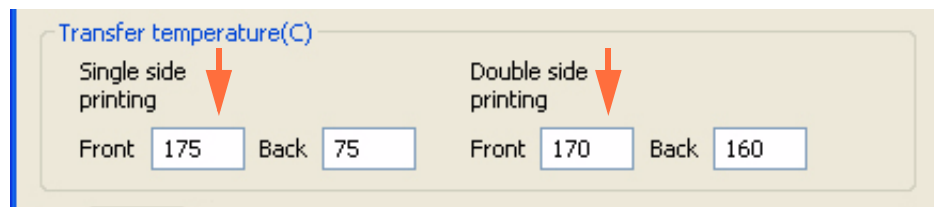

- e. Print a test card; see [Section B.3](#).
- f. Examine the test card.
  - If there is noticeable improvement, continue decreasing the front transfer temperature by 5, printing a test card, and examining the resulting card. Stop when the problem is corrected or there is no more improvement. If the problem is corrected, no more adjustment is required; otherwise go to [Step 2](#).
  - If there is no noticeable improvement, return the temperature to its default setting; and go to [Step 2](#).

**Step 2.** Decrease Back Transfer Temperature:

- a. Go to the Card Specifications window.
- b. Make a note of the default back transfer temperature settings.
- c. Decrease the appropriate (single or double side) back transfer temperature by 5.
- d. Click on the **OK** button.

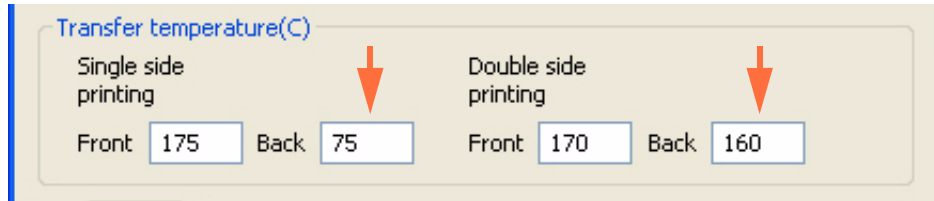

- e. Print a test card.
- f. Examine the test card.
  - If there is noticeable improvement, continue decreasing the back transfer temperature by 5, printing a test card, and examining the resulting card. Stop when the problem is corrected or there is no more improvement. If the problem is corrected, no more adjustment is required; otherwise go to [Step 3](#).
  - If there is no noticeable improvement, return the temperature to its default setting; and go to [Step 3](#).

## Setting Custom Card Specifications Adjustments

### Step 3. Increase Transfer Output Speed

- a. From the Card Specifications window, make a note of the default transfer output speed settings.
- b. Increase the appropriate (single or double) transfer output speed by 0.2.
- c. Click on the **OK** button.

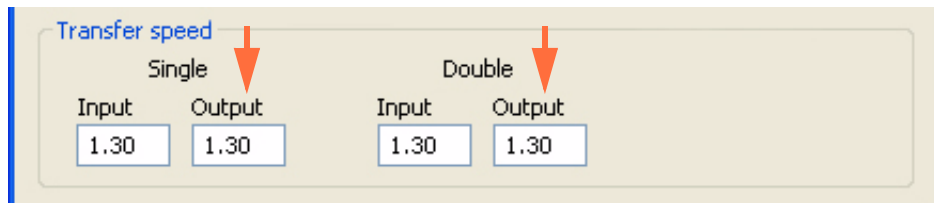

- d. Print a test card.
- e. Examine the test card.
  - If there is noticeable improvement, continue increasing the transfer output speed by 0.2, printing a test card, and examining the resulting card. Stop when the problem is corrected or there is no more improvement. If the problem is corrected, no more adjustment is required; otherwise go to [Step 4](#).
  - If there is no noticeable improvement, return the speed to its default setting; and go to [Step 4](#).

**Step 4.** Increase Transfer Input Speed

- a. From the Card Specifications window, make a note of the default transfer input speed settings.
- b. Increase the appropriate (single or double) transfer input speed by 0.2.
- c. Click on the **OK** button.

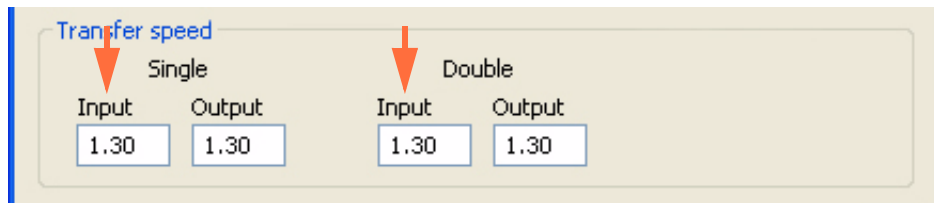

- d. Print a test card.
- e. Examine the test card.
  - If there is noticeable improvement, continue increasing the transfer input speed by 0.2, printing a test card, and examining the resulting card. Stop when the problem is corrected or there is no more improvement. If the problem is corrected, no more adjustment is required. If the problem persists, contact Zebra Technical Support.
  - If there is no noticeable improvement, return the transfer input speed to its default setting; and contact Zebra Technical Support.

## B.4.5 Flash

Flash is usually caused by too much energy being transferred to the card (i.e., temperatures are too high or input speed is too slow) and not allowing enough time for the cards to cool while exiting the transfer station (i.e., exit speed is too fast).

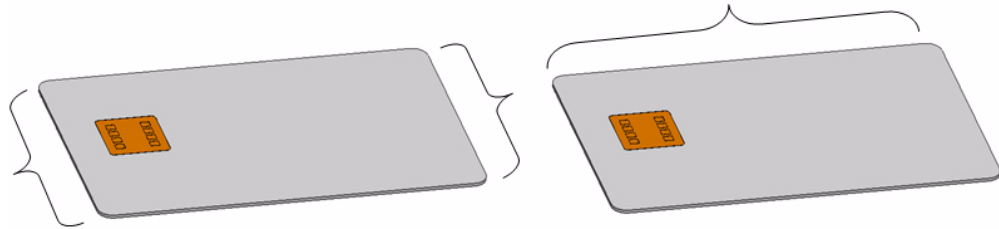

### Side Edge

**Step 1.** Decrease Front Transfer Temperature:

- a. Go to the Card Specifications window; see [Section B.3](#).
- b. Make a note of the default front transfer temperature settings.
- c. Decrease the appropriate (single or double side) front transfer temperature by 5.
- d. Click on the **OK** button.

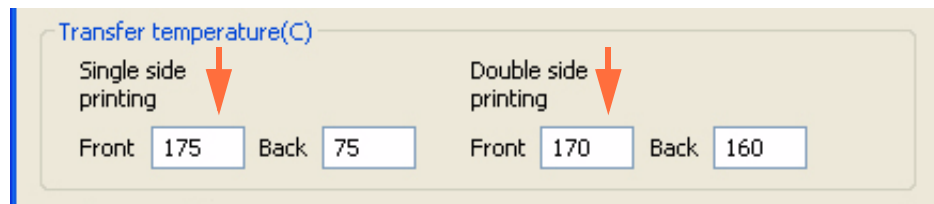

- e. Print a test card; see [Section B.3](#).
- f. Examine the test card.
  - If there is noticeable improvement, continue decreasing the front transfer temperature by 5, printing a test card, and examining the resulting card. Stop when the problem is corrected or there is no more improvement. If the problem is corrected, no more adjustment is required; otherwise go to [Step 2](#).
  - If there is no noticeable improvement, return the temperature to its default setting; and go to [Step 2](#).

**Step 2.** Decrease Back Transfer Temperature:

- a. Go to the Card Specifications window.
- b. Make a note of the default back transfer temperature settings.
- c. Decrease the appropriate (single or double side) back transfer temperature by 5.
- d. Click on the **OK** button.

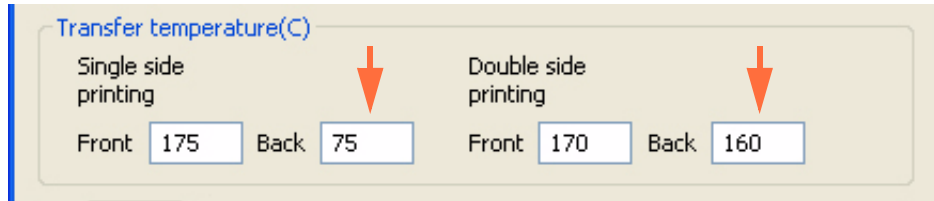

- e. Print a test card.
- f. Examine the test card.
  - If there is noticeable improvement, continue decreasing the back transfer temperature by 5, printing a test card, and examining the resulting card. Stop when the problem is corrected or there is no more improvement. If the problem is corrected, no more adjustment is required; otherwise go to [Step 3](#).
  - If there is no noticeable improvement, return the temperature to its default setting; and go to [Step 3](#).

## Setting Custom Card Specifications Adjustments

### Step 3. Decrease Transfer Output Speed

- a. From the Card Specifications window, make a note of the default transfer output speed settings.
- b. Decrease the appropriate (single or double) transfer output speed by 0.2.
- c. Click on the **OK** button.

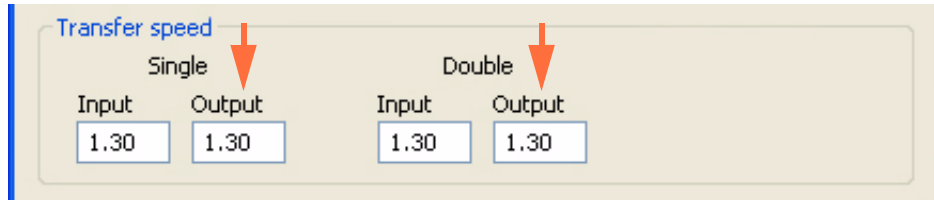

- d. Print a test card.
- e. Examine the test card.
  - If there is noticeable improvement, continue decreasing the transfer output speed by 0.2, printing a test card, and examining the resulting card. Stop when the problem is corrected or there is no more improvement. If the problem is corrected, no more adjustment is required. If the problem persists, contact Zebra Technical Support.
  - If there is no noticeable improvement, return the transfer output speed to its default setting; and contact Zebra Technical Support.



## Leading Edge

### Step 1. Decrease Front Transfer Temperature:

- a. Go to the Card Specifications window; see [Section B.3](#).
- b. Make a note of the default front transfer temperature settings.
- c. Decrease the appropriate (single or double side) front transfer temperature by 5.
- d. Click on the **OK** button.

Transfer temperature(C)

Printing Type	Side	Temperature (C)
Single side printing	Front	175
	Back	75
Double side printing	Front	170
	Back	160

- e. Print a test card.
- f. Examine the test card; see [Section B.3](#).
  - If there is noticeable improvement, continue decreasing the front transfer temperature by 5, printing a test card, and examining the resulting card. Stop when the problem is corrected or there is no more improvement. If the problem is corrected, no more adjustment is required; otherwise go to [Step 2](#).
  - If there is no noticeable improvement, return the temperature to its default setting; and go to [Step 2](#).

## Setting Custom Card Specifications

### Adjustments

#### Step 2. Decrease Back Transfer Temperature:

- a. Go to the Card Specifications window.
- b. Make a note of the default back transfer temperature settings.
- c. Decrease the appropriate (single or double side) back transfer temperature by 5.
- d. Click on the **OK** button.

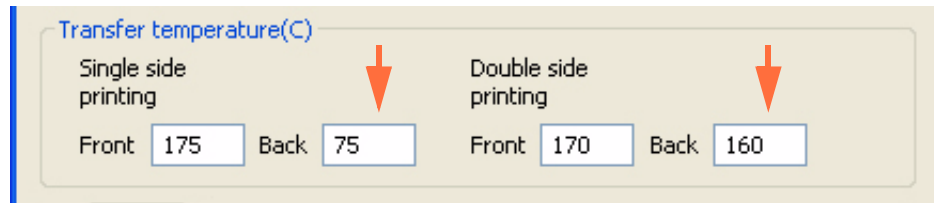

- e. Print a test card.
- f. Examine the test card.
  - If there is noticeable improvement, continue decreasing the back transfer temperature by 5, printing a test card, and examining the resulting card. Stop when the problem is corrected or there is no more improvement. If the problem is corrected, no more adjustment is required. If the problem persists, contact Zebra Technical Support.
  - If there is no noticeable improvement, return the back transfer temperature to its default setting; and contact Zebra Technical Support.

## B.4.6 Special Cases

### Flash on Smart Card Chip

**Step 1.** Decrease Front Transfer Temperature:

- a. Go to the Card Specifications window; see [Section B.3](#).
- b. Make a note of the default front transfer temperature settings.
- c. Decrease the appropriate (single or double side) front transfer temperature by 5.
- d. Click on the **OK** button.

Transfer temperature(C)

Printing Type	Front (C)	Back (C)
Single side printing	175	75
Double side printing	170	160

- e. Print a test card.
- f. Examine the test card; see [Section B.3](#).
  - If there is noticeable improvement, continue decreasing the front transfer temperature by 5, printing a test card, and examining the resulting card. Stop when the problem is corrected or there is no more improvement. If the problem is corrected, no more adjustment is required; otherwise go to [Step 2](#).
  - If there is no noticeable improvement, return the temperature to its default setting; and go to [Step 2](#).

## Setting Custom Card Specifications

### Adjustments

#### Step 2. Decrease Back Transfer Temperature:

- a. Go to the Card Specifications window.
- b. Make a note of the default back transfer temperature settings.
- c. Decrease the appropriate (single or double side) back transfer temperature by 5.
- d. Click on the **OK** button.

Transfer temperature(C)			
Single side printing			
Front	175	Back	75
Double side printing			
Front	170	Back	160

- e. Print a test card.
- f. Examine the test card.
  - If there is noticeable improvement, continue decreasing the back transfer temperature by 5, printing a test card, and examining the resulting card. Stop when the problem is corrected or there is no more improvement. If the problem is corrected, no more adjustment is required; otherwise go to [Step 3](#).
  - If there is no noticeable improvement, return the temperature to its default setting; and go to [Step 3](#).

**Step 3.** Increase Transfer Output Speed

- a. From the Card Specifications window, make a note of the default transfer output speed settings.
- b. Increase the appropriate (single or double) transfer output speed by 0.2.
- c. Click on the **OK** button.

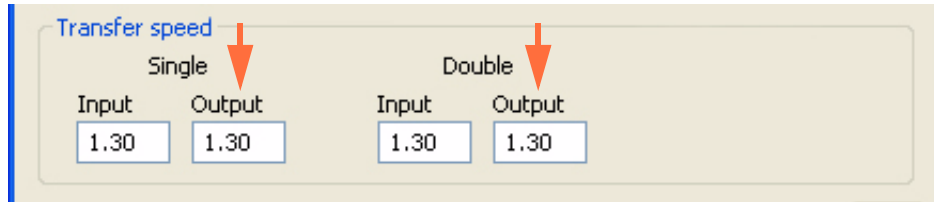

- d. Print a test card.
- e. Examine the test card.
  - If there is noticeable improvement, continue increasing the transfer output speed by 0.2, printing a test card, and examining the resulting card. Stop when the problem is corrected or there is no more improvement. If the problem is corrected, no more adjustment is required; otherwise go to [Step 4](#).
  - If there is no noticeable improvement, return the transfer output speed to its default setting; and go to [Step 4](#).

## Setting Custom Card Specifications

### Adjustments

#### Step 4. Increase Transfer Input Speed

- a. From the Card Specifications window, make a note of the default transfer input speed settings.
- b. Increase the appropriate (single or double) transfer input speed by 0.2.
- c. Click on the **OK** button.

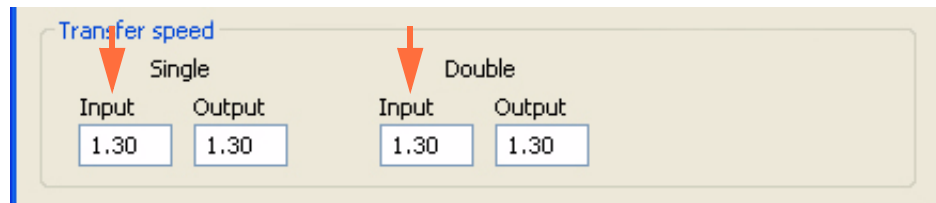

- d. Print a test card.
- e. Examine the test card.
  - If there is noticeable improvement, continue increasing the transfer input speed by 0.2, printing a test card, and examining the resulting card. Stop when the problem is corrected or there is no more improvement. If the problem is corrected, no more adjustment is required. If the problem persists, contact Zebra Technical Support.
  - If there is no noticeable improvement, return the transfer input speed to its default setting; and contact Zebra Technical Support.

## Flash on Magnetic Stripe

**Step 1.** Decrease Back Transfer Temperature:

- a. Go to the Card Specifications window; see [Section B.3](#).
- b. Make a note of the default back transfer temperature settings.
- c. Decrease the appropriate (single or double side) back transfer temperature by 5.
- d. Click on the **OK** button.

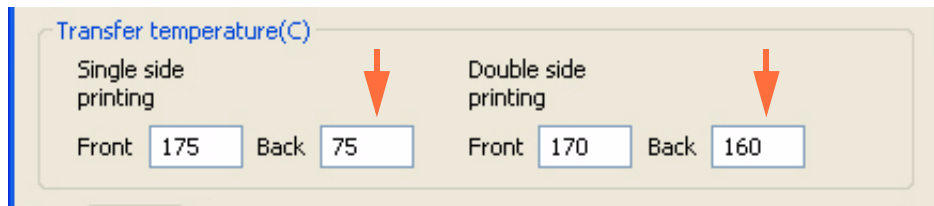

- e. Print a test card.
- f. Examine the test card; see [Section B.3](#).
  - If there is noticeable improvement, continue decreasing the back transfer temperature by 5, printing a test card, and examining the resulting card. Stop when the problem is corrected or there is no more improvement. If the problem is corrected, no more adjustment is required; otherwise go to [Step 2](#).
  - If there is no noticeable improvement, return the temperature to its default setting; and go to [Step 2](#).

## Setting Custom Card Specifications

### Adjustments

#### Step 2. Increase Transfer Output Speed

- a. From the Card Specifications window, make a note of the default transfer output speed settings.
- b. Increase the appropriate (single or double) transfer output speed by 0.2.
- c. Click on the **OK** button.

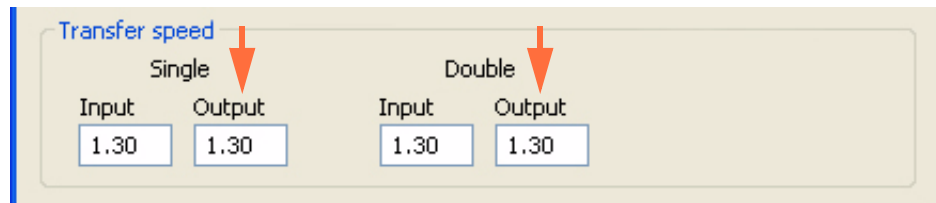

- d. Print a test card.
- e. Examine the test card.
  - If there is noticeable improvement, continue increasing the transfer output speed by 0.2, printing a test card, and examining the resulting card. Stop when the problem is corrected or there is no more improvement. If the problem is corrected, no more adjustment is required; otherwise go to [Step 3](#).
  - If there is no noticeable improvement, return the transfer output speed to its default setting; and go to [Step 3](#).



**Step 3.** Increase Transfer Input Speed

- a. From the Card Specifications window, make a note of the default transfer input speed settings.
- b. Increase the appropriate (single or double) transfer input speed by 0.2.
- c. Click on the **OK** button.

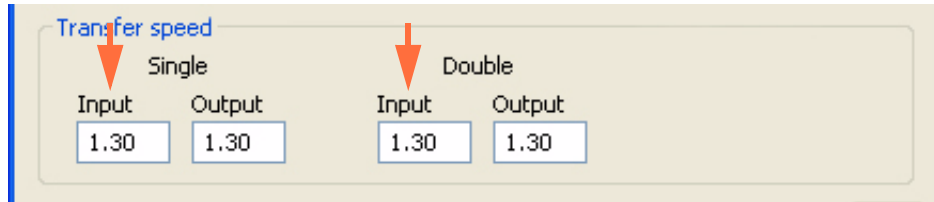

- d. Print a test card.
- e. Examine the test card.
  - If there is noticeable improvement, continue increasing the transfer input speed by 0.2, printing a test card, and examining the resulting card. Stop when the problem is corrected or there is no more improvement. If the problem is corrected, no more adjustment is required. If the problem is corrected, no more adjustment is required; otherwise go to [Step 4](#).
  - If there is no noticeable improvement, return the transfer input speed to its default setting; and go to [Step 4](#).

## Setting Custom Card Specifications

### Adjustments

#### Step 4. Decrease Front Transfer Temperature:

- a. Go to the Card Specifications window.
- b. Make a note of the default front transfer temperature settings.
- c. Decrease the appropriate (single or double side) front transfer temperature by 5.
- d. Click on the **OK** button.

Transfer temperature(C)

Printing Type	Front (C)	Back (C)
Single side printing	175	75
Double side printing	170	160

- e. Print a test card.
- f. Examine the test card; see [Section B.3](#).
  - If there is noticeable improvement, continue decreasing the front transfer temperature by 5, printing a test card, and examining the resulting card. Stop when the problem is corrected or there is no more improvement. If the problem is corrected, no more adjustment is required. If the problem persists, contact Zebra Technical Support.
  - If there is no noticeable improvement, return the front transfer temperature to its default setting; and contact Zebra Technical Support.

## Excess Leading-Edge Flash on Mag Cards

Use image with black printed line or text above the mag stripe (arrows below).



To assist with this issue, you can use the Inhibit pop-up window, which allows you to select the inhibit panel area for the mag stripe, signature panel, or other non-printing areas of a card; see [Inhibit Pop-Up](#) on page 66 for details.

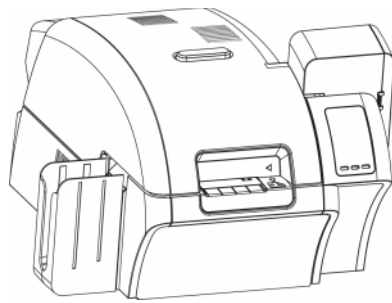

# *Appendix C*

---

## Network Operations



This section covers:

Setting Up a Network Printer .....	162
Pooling .....	169

## Setting Up a Network Printer

Use this procedure if you have already installed an ethernet printer on your system (refer to [Section 2](#)), and you want to install a second ethernet printer on the network via the Microsoft **Add Printer Wizard**.

**Step 1.** Click on the **Start** button, select *Control Panel > Printers and Faxes> Add a printer*.

**Step 2.** Observe the *Add Printer Wizard* window open.



**Step 3.** Click on the **Next** button, and observe the *Local or Network Printer* window.

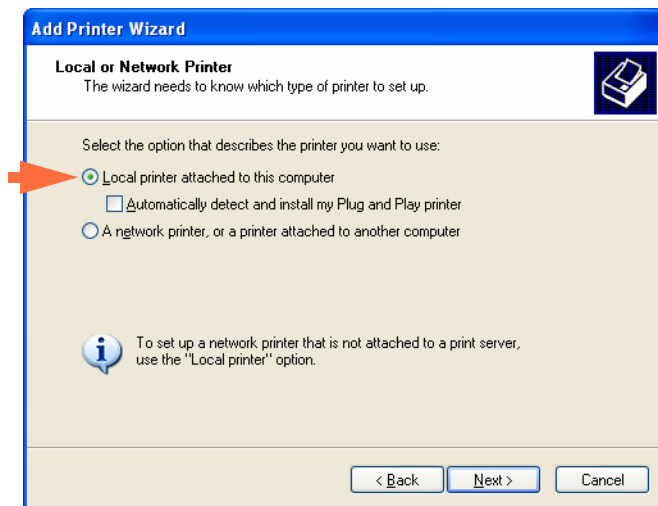

**Step 4.** Select *Local printer attached to this computer*. Ensure *Automatically detect and install my Plug and Play printer* is **NOT** checked.

**Step 5.** Click on the **Next** button

**Step 6.** Observe the *Select a Printer Port* window.

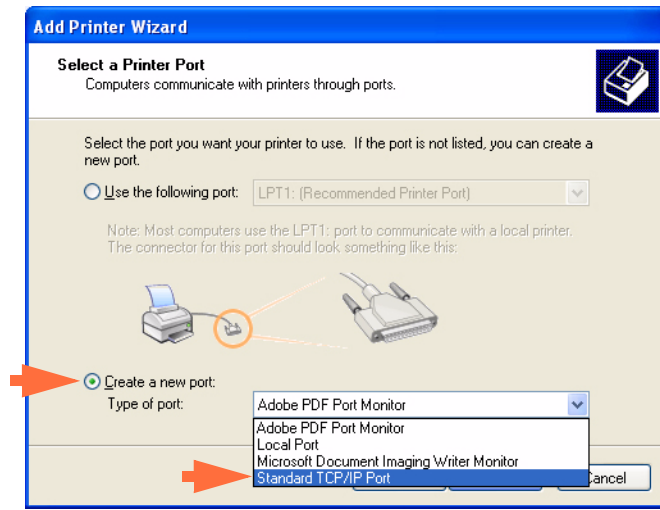

**Step 7.** Click on the *Create a new port* radio button.

**Step 8.** From the dropdown menu, select *Standard TCP/IP Port*.

**Step 9.** Click on the **Next** button, and observe the *Add Standard TCP/IP Port Wizard* window.

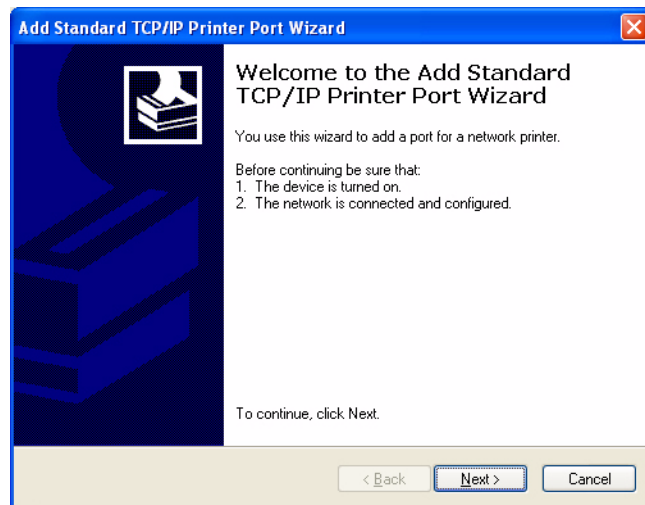

**Step 10.** Be sure that your printer is turned on and the network is connected and configured.

**Step 11.** Click on the **Next** button.

**Step 12.** Observe a second *Add Standard TCP/IP Port Wizard* window.



**Note •** You can get the IP Address via the OCP: INFO button > NETWORK INFO > IP.

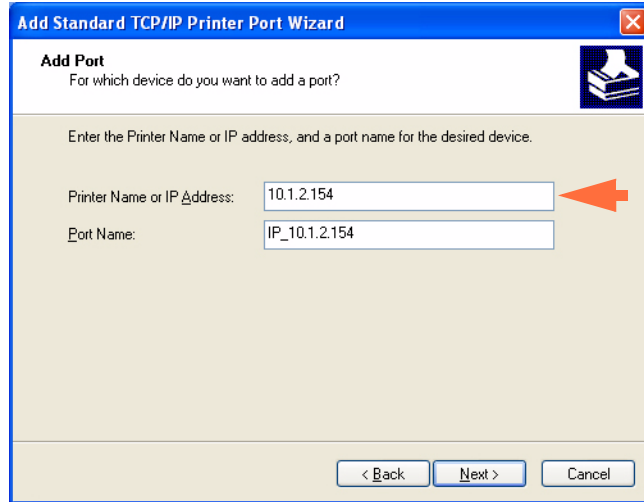

**Step 13.** Enter the IP Address of your printer. Note that the Port Name will automatically be filled in when you enter the IP Address. **Do not change the Port Name.**

**Step 14.** Click on the **Next** button, and observe the *Additional Port Information Required* window.

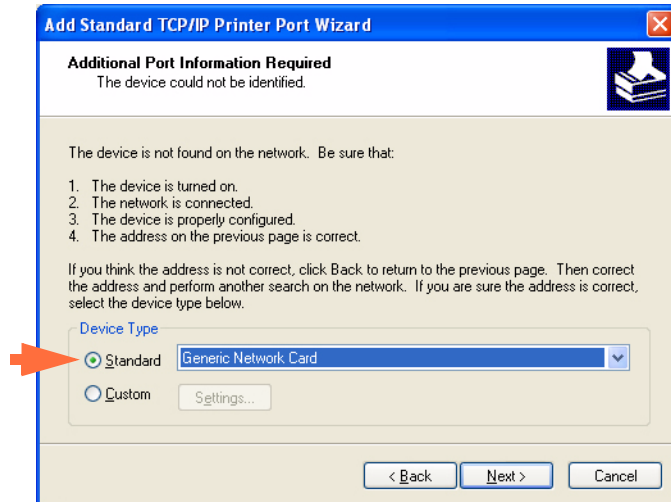

**Step 15.** Click on the *Standard* radio button; and from the dropdown menu, select *Generic Network Card*.

**Step 16.** Click on the **Next** button.



**Step 17.** Observe the *Completing the Add Standard TCP/IP Printer Port Wizard* window.

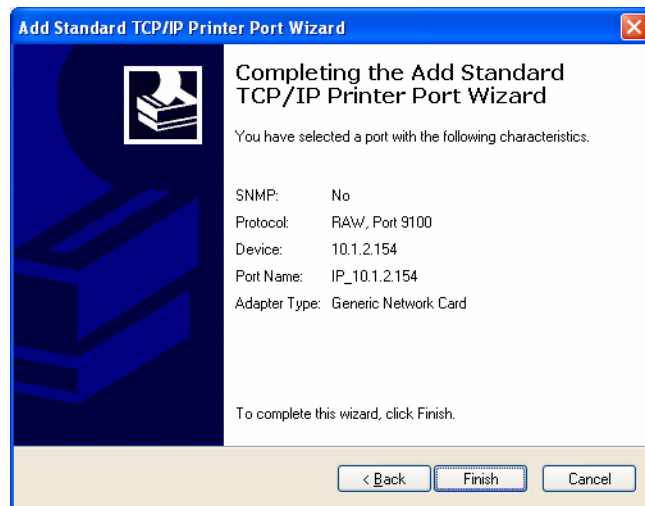

**Step 18.** Click on the **Finish** button, and observe the *Install Printer Software* window.

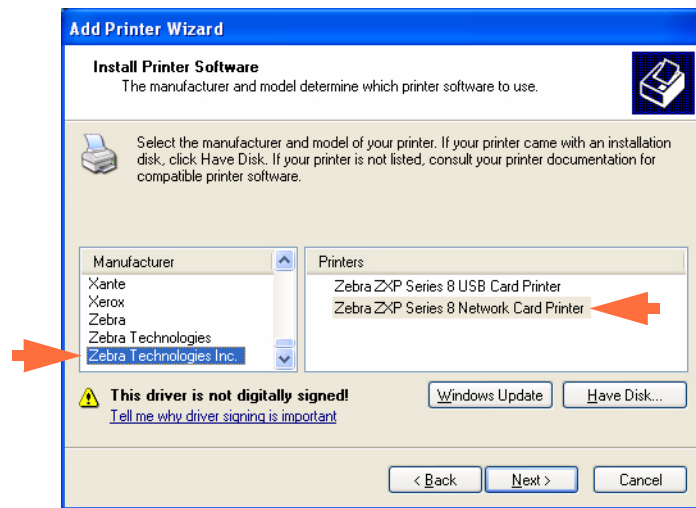

**Step 19.** Select the Manufacturer (Zebra Technologies Inc) and the Printers (Zebra ZXP Series 8 Network Card Printer).

**Step 20.** Click on the **Next** button.

**Step 21.** Observe the *Use Existing Driver* window.

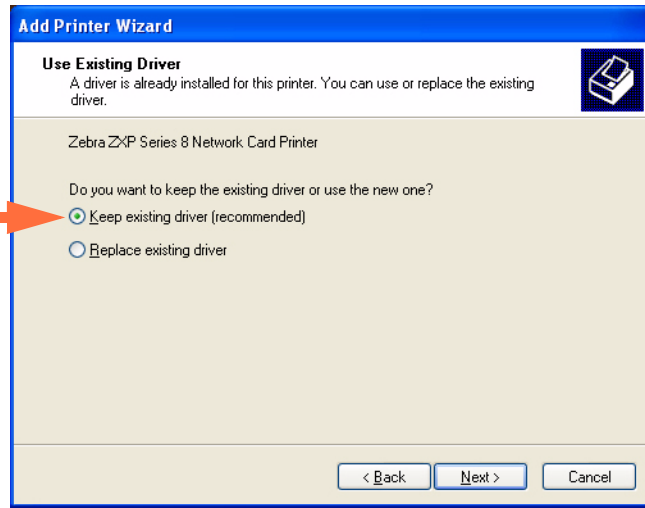

**Step 22.** Select the *Keep existing driver* radio button.

**Step 23.** Click the **Next** button, and observe the *Name Your Printer* window.

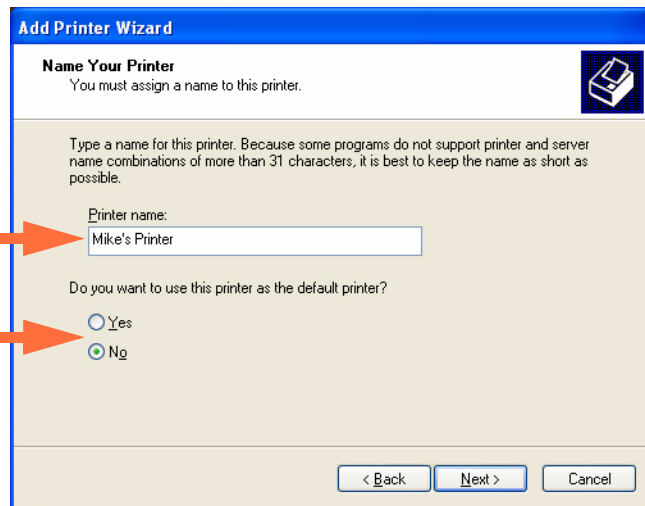

**Step 24.** Enter the printer name, use the default name, or add more information to indicate the printer location; e.g., Mike's Office, Hallway, Room 33, etc.

**Step 25.** Select the appropriate radio button in answer to the question *Do you want to use this printer as the default printer?*

**Step 26.** Click the **Next** button.

**Step 27.** Observe the *Printer Sharing* window.

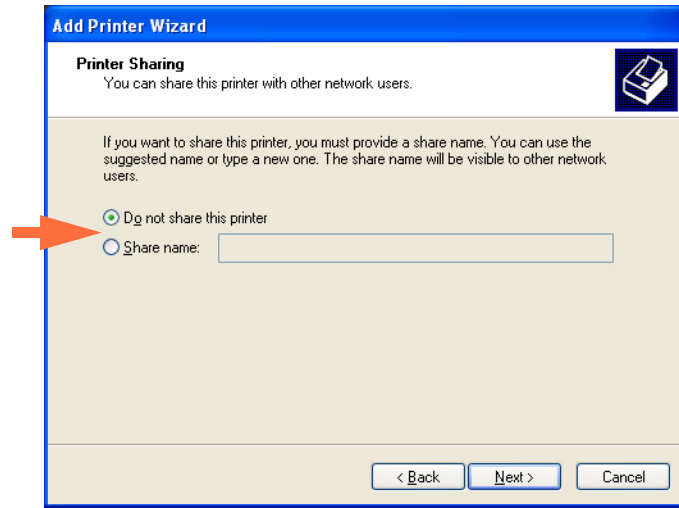

**Step 28.** Select the appropriate radio button in answer to the question *Do you want to share this printer...?* Enter the *Share name* if applicable.

**Step 29.** Click the **Next** button, and observe the *Print Test Page* window.

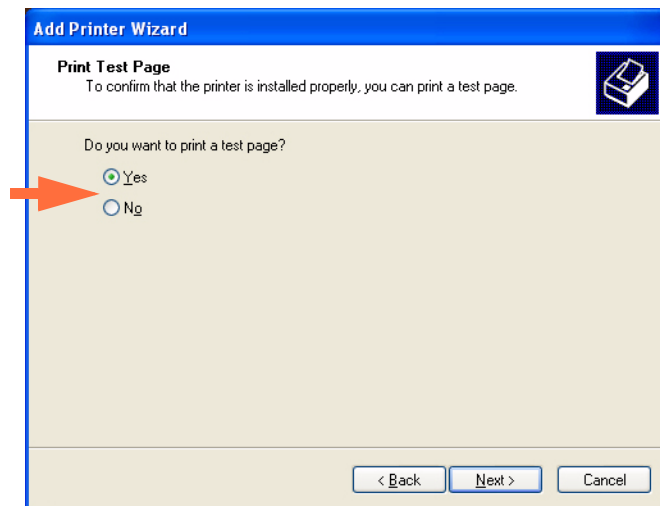

**Step 30.** Select the appropriate radio button in answer to the question *Do you want to print a test page?*

**Step 31.** Click the **Next** button.

**Step 32.** Observe the *Completing the Add Printer Wizard* window.

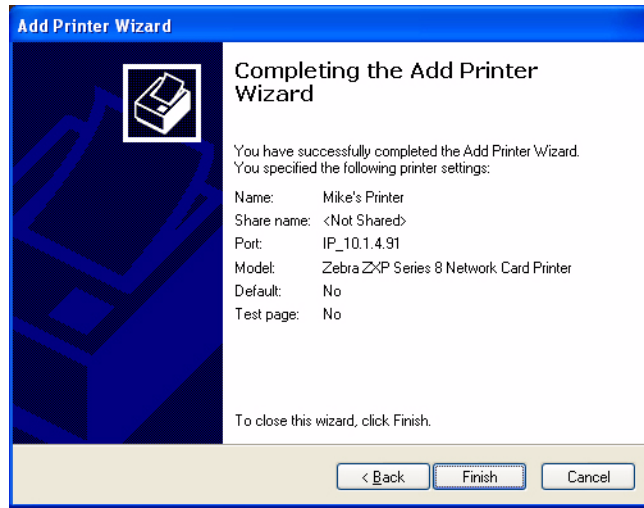

**Step 33.** Click on the **Finish** button to complete the *Add Printer Wizard*.

You have successfully installed the network printer.

## Pooling

### Setting Up the Printer Pool

Printer Pooling is a standard feature of Windows, which lets you spread your printed output across a pool of several printers. In this example, we will install and setup the three network printers to be used for pooling.

**Step 1.** Before proceeding to pool the printers, test them individually, and be sure they are configured similarly. Specifically, check the following:

- Ribbon panel configuration (ribbon type, and what prints on which side of the card).
- Mag encoding configuration.
- Black extraction configuration (if applicable).

**Step 2.** Access the Ports Tab.

To access the Ports tab, select *Start > Printers and Faxes*. Right click on the *Zebra ZXP Series 8 Card Printer* listing. Select *Properties > Ports*.

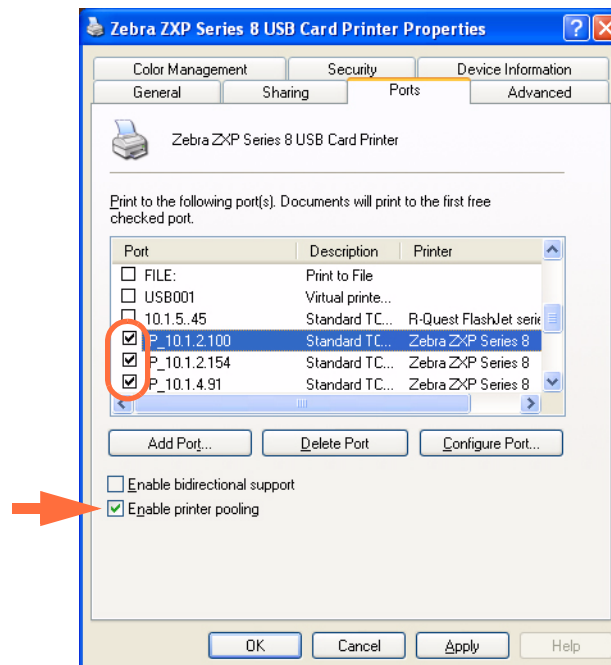

**Step 3.** Select the *Enable printer pooling* checkbox (arrow above).

**Step 4.** Select the three printers by clicking on the associated checkbox (circle above).

## Using the Printer Pool



**Note** • Send print jobs to the pool, **not** to an individual printer.

When the first printer has taken as many jobs as it can handle (that being two jobs - one to be printed immediately, the other waiting), the following jobs “spill over” to the second printer, and then to the third printer.

Note that if you are only printing two jobs, they would both go to the first printer. Pooling is a spill-over methodology. It does not balance printer usage.

Once the pool has been set up, maintenance and configuration changes should be done through the menus for each individual printer, **not** through the pool (which can produce undesirable results).



**Important** • The effect of any maintenance and/or changes can (and should) be tested by sending print jobs **separately** to each printer, not to the pool.

# Appendix D

## Magnetic Card Encoder



### Introduction

This Appendix includes operation and maintenance requirements for Printers with the optional magnetic card stripe encoder.

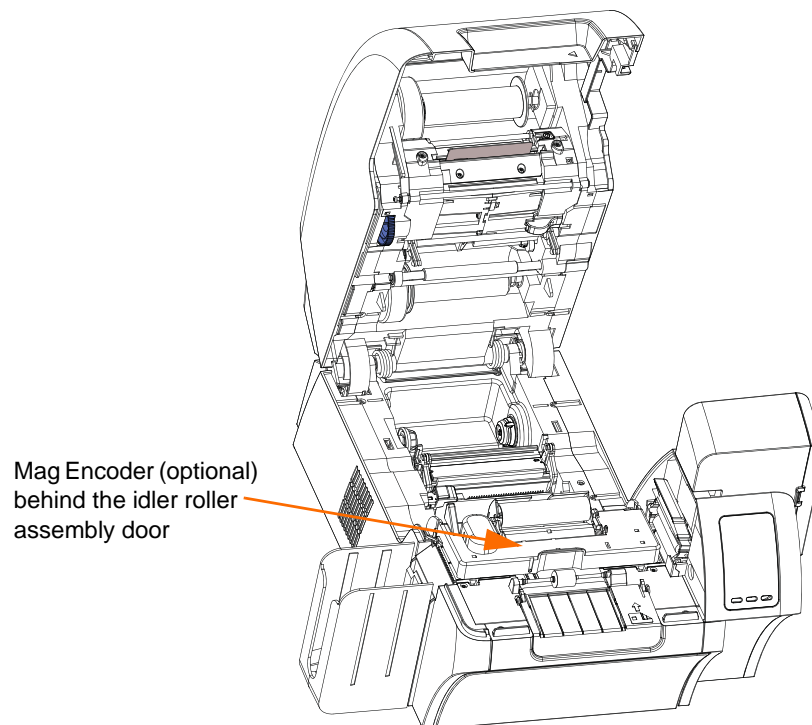

The magnetic encoder can be set for either high or low coercivity, which must match the cards being used. Use the printer driver to change the encoder setting.

## Driver Setting

The **Card Setup** tab allows the user to specify the Magnetic Encoder Card Type in use. Based on your selection, the printer automatically adjusts various printer properties for optimum performance.

If your card type is not listed in the drop-down menu, select *Custom* and fill out the Card Specifications pop-up screen.

To access the Card Setup Tab, select *Start > Printers and Faxes*. Right click on the *Zebra ZXP Series 8 Card Printer* listing; and select *Printing Preferences > Card Setup*.

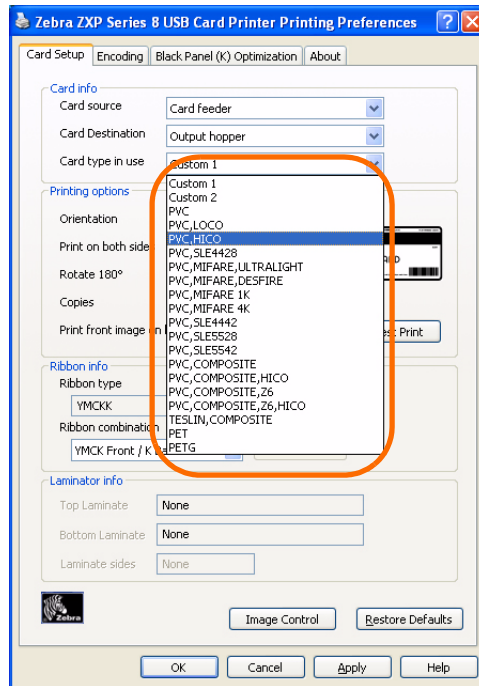

- Make the appropriate Magnetic Encoder Card Type selection.



## Media Loading Orientation



**Note** • ONLY USE cards that comply with ISO 7810 and 7811 standards for magnetic stripe cards. The magnetic stripe must be flush to the surface of the card to work properly. Never use cards which have taped-on magnetic stripes.

Place the cards in the Input Hopper in the correct orientation as shown (with the magnetic stripe down and facing to the rear). Ensure that the cards are seated properly the hopper.

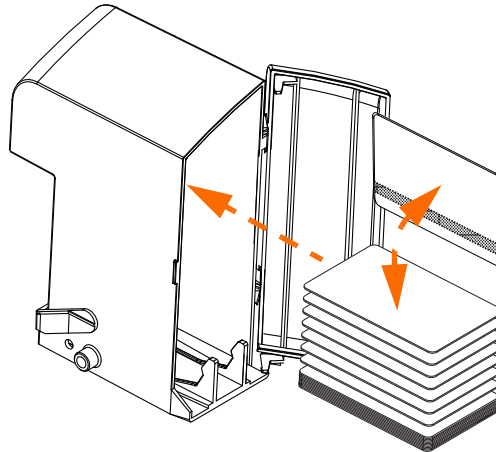

## Magnetic Encoder Cleaning

The Magnetic Encoder is cleaned as part of the printer cleaning process; see [Section 6](#). If the frequency of encoding errors increases, the head may need additional cleaning. To clean, only use foam-tipped swabs.



---

**Caution** • Never use a sharp object or any abrasive to scrape deposits from the Magnetic Encoder. Permanent damage to the Magnetic Head will result.

---

- Step 1.** Open the Door.
- Step 2.** Open the idler roller assembly door.
- Step 3.** Bend the Cleaning Swab to release the cleaning fluid.
- Step 4.** Clean the Magnetic Encoder by moving Cleaning Swab tip side-to-side across the head elements. To re-order Cleaning Swabs, see the Media List on the **User Documentation and Drivers CD** supplied with this printer.
- Step 5.** Close the idler roller assembly door.
- Step 6.** Close the Door.

## Magnetic Encoding Type

### ISO (Default)

The encoder reads and writes standard ISO track data formats in standard ISO track locations. The following shows the three standard ISO tracks.

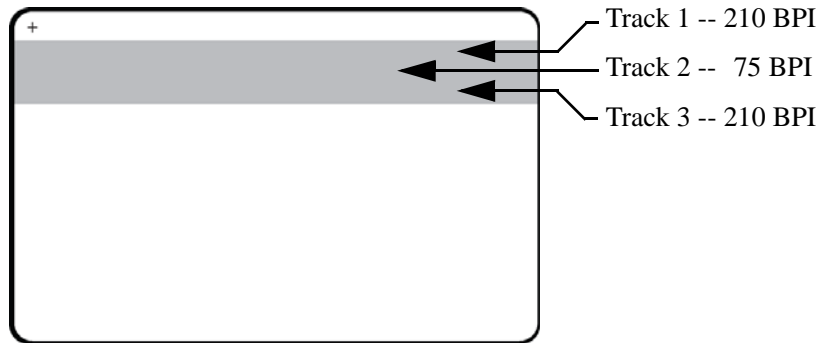

Each track can be encoded and decoded with ASCII characters in the standard default ISO data formats:

Track	Density (bits per inch)	Bits per character	Character parity	Length (characters)	LRC parity	Start sentinel	End sentinel	Start sentinel offset inches (mm)
1	210	7	Odd	76	Even	%	?	0.293" (7.4)
2	75	5	Odd	37	Even	;	?	0.293" (7.4)
3	210	5	Odd	104	Even	;	?	0.293" (7.4)

The magnetic encoder can read or encode up to 3 tracks of digital information onto CR-80 cards incorporating a HiCo or LoCo magnetic stripe in the ISO 7811 format.

Encoding for the three tracks uses the ISO 7811 format.

- Track 1 uses 210 BPI (bits per inch) encoding in the International Air Transport Association (IATA) format of 79 alphanumeric characters, at 7 bits per character.
- Track 2 uses 75 BPI encoding to store 40 numeric characters at 5 bits per character in American Banking Association (ABA) format.
- Track 3 uses 210 BPI encoding of 107 numeric characters at 5 bits per character in THRIFT format.

The ISO data formats include a preamble (all zeros), a start character, data (7-bit or 5-bit as specified by ISO), a stop character, and a longitudinal redundancy check (LRC) character. The 7-bit data format has 6 bits of encoded data and a parity bit. The 5-bit data format has 4 bits of encoded data and a parity bit.

The ISO data formats include a data field separator (or delimiter) that allows parsing of the encoded track data. An example of separate data fields would be the ABA data format (Track 2) that includes a Primary Account Number (PAN) field and an account information field (for expiration date, country code, etc.).

## AAMVA

Alpha-numeric characters on Tracks 1 and 3, numerals only on Track 2.

Track	Density (bits per inch)	Bits per character	Character parity	Length (characters)	LRC parity	Start sentinel	End sentinel	Start sentinel offset inches (mm)
1	210	7	Odd	79	Even	%	?	0.293" (7.4)
2	75	5	Odd	37	Even	;	?	0.293" (7.4)
3	210	7	Odd	79	Even	%	?	0.293" (7.4)

## CUSTOM

If a custom format is desired, the ISO standard format may be used as a starting point. The standard format can then be modified by assigning different values to any or all of the **density**, **character**, and **sentinel** attributes. (If any of these attributes is missing, its corresponding value in the standard ISO format will be substituted.)

## BINARY

The binary option allows the user to specify directly the value for each bit on the mag stripe:

In this “direct binary” mode, it is the host’s responsibility to fully populate the magnetic stripe; i.e., the hex data provided by the host must include the leading zeroes, start sentinel, data, end sentinel, LRC, and trailing zeroes. Note that the magnetic stripe is encoded from the right-hand end as viewed from the “stripe” side, with the stripe uppermost. The least significant bit of the data is encoded first.

A sufficient number of leading zeroes should be prepended to offset the start sentinel by approximately 0.3" (7.5 mm) from the right-hand end, as in the ISO format. Care should be taken to ensure that the payload data does not exceed the capacity of the tracks at their specified recording densities. (In the **binary** mode, out-of-range data is not recorded, and no error condition will result.)

A CR-80 size card has a nominal capacity of 252 bits per track at 75 BPI, and 708 bits at 210 BPI. These capacities equate approximately to 31 hex bytes (248 binary bits) and 88 hex bytes respectively.

## Encoder Macro Commands

With ZXP Series 8 printers, we provide support for pass-through mag encoding commands.

The application developer or user can use a preamble or Macro to indicate to the driver that the data following the Preamble or Macro is to be mag encoded.

The user can have encoding and printing data on the same card, and the driver will filter out the encoding data from the printing data. The user does not have to know job control syntax or ZMotif commands to send mag encoding commands to the printer.

Supported Macro commands are:

1. C01<Track1 Data>  
C02<Track2 Data>  
C03<Track3 Data>
  
2. \${1<Track1 data>}\$  
\${2<Track2 data>}\$  
\${3<Track3 data>}\$
  
3. ~1=<Track1 data>  
~2=<Track2 data>  
~3=<Track3 data>

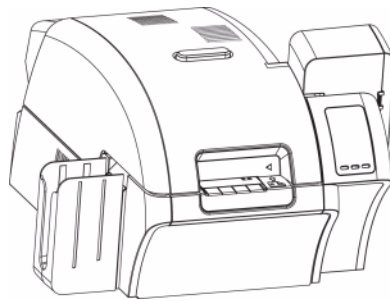

# APPENDIX E

## Smart Card Options



### Introduction

This Appendix contains information on the additional operations of a Printer equipped with one or more of the available Smart Card options.

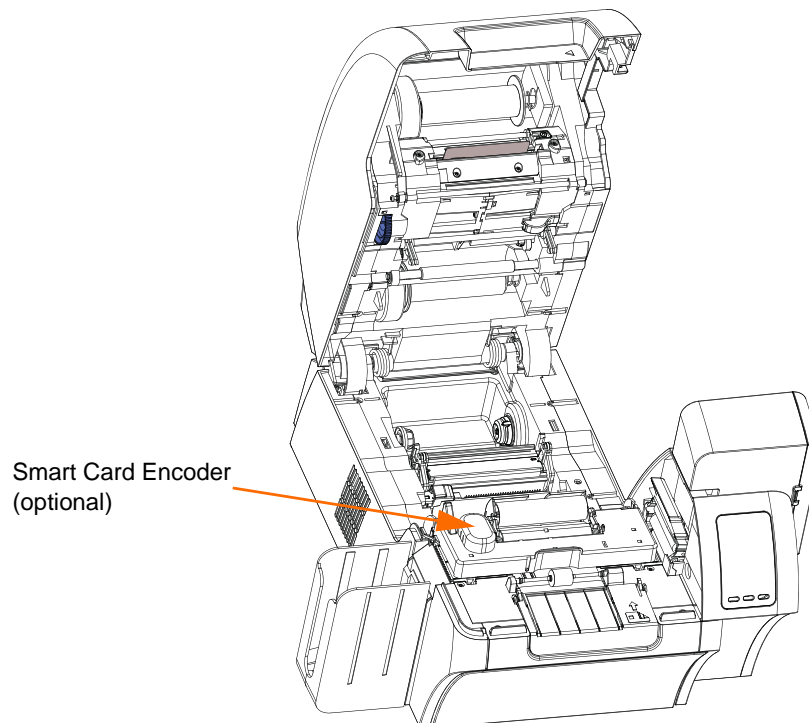

Smart Cards can have a built-in microcomputer and/or memory to store fingerprints, voice recognition patterns, medical records, and other such data. All other printer operations remain the same as the standard models.

## Encoding and Reading Smart Cards

Encoding data onto Smart Cards and reading the data previously encoded on them is totally under control of the application software; no operator action is required.

If you experience any problems with encoding or reading data, refer to the users manual or other documentation for the application software.

## Driver Setting

The **Card Setup** tab allows the user to specify the Smart Card Type in use. Based on your selection, the printer automatically adjusts various printer properties for optimum printer performance.

If your card type is not listed in the drop-down menu, select *Custom* and fill out the Card Specifications pop-up screen.

To access the Card Setup Tab, select *Start > Printers and Faxes*. Right click on the *Zebra ZXP Series 8 Card Printer* listing; and select *Printing Preferences > Card Setup*.

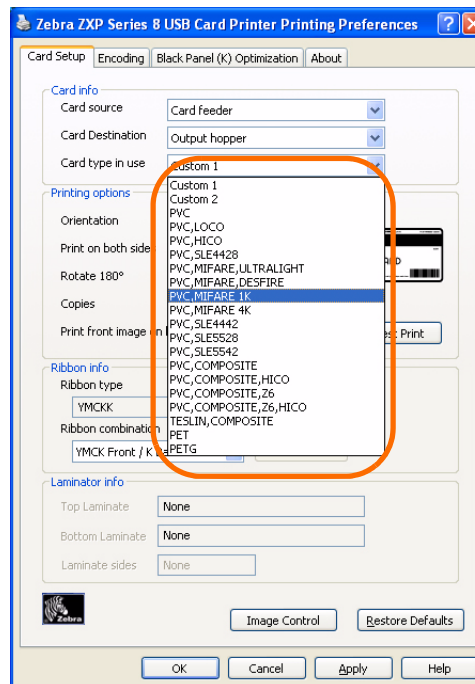

- Make the appropriate Smart Card Type selection.



## Contact Smart Cards

Contact Smart Cards have a pad of contacts on the surface of the card that connect to the circuitry embedded into the card.

The printer responds to commands that position the card at the contact location, where the printer connects to the contacts on the Smart Card. Data to be encoded onto the Smart Card, and data read from the Smart Card, can interface via a connector on the printer's rear panel (*Contact Station*), or encoding/decoding can be performed by logic on the printer's Main PCBA (*Contact Encoder*).

All other printer operations remain the same as the standard models.

## Media Loading Orientation for Contact Smart Cards

Place the cards in the Input Hopper in the correct orientation as shown (with the gold-plated Smart Card contacts at the top surface of the card and facing to the left). Ensure that the cards are seated properly the hopper.

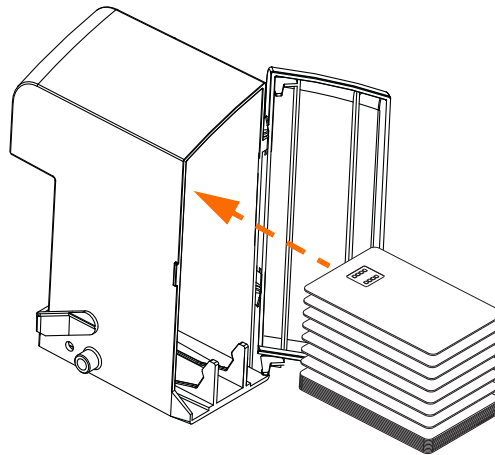

## Contact Station Smart Card Interface

When a command to the printer interface sends a card to the Smart Card Contact Station, the printer connects the Smart Card Contact Station to the female DB-9 connector on the rear of the printer.

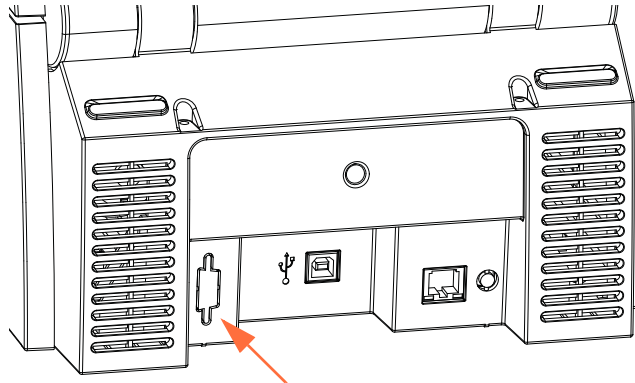

DB-9 Connector location for Smart Card Contact Station

An attached external Smart Card Programmer can be used to program Smart Card chips. The following table shows the Smart Card Contact Points.

Pin	Smart Card Contact Points	DB-9	Smart Card Contact Points
1	C1 (VCC)	6	C6 (Vpp)
2	C2 (Reset)	7	C7 (I/O)
3	C3 (Clock)	8	C8 (RFU)
4	C4 (RFU)	9	(GND when chip is at station)
5	C5 (GND)		

## Contactless Smart Cards

Rather than using a contact pad, Contactless Smart Cards use various short-range radio technologies to “connect” to the printer. The printer moves the card to an antenna location on the card path, and the encoding or decoding occurs. All other printer operations remain the same.

### Media Loading Orientation for Contactless Smart Cards

For Contactless Smart Cards, orientation is not a consideration.

### Printing on Contactless Smart Cards

With reverse transfer printing technology, there are no restrictions when designing material to be printed on Contactless Smart Cards.

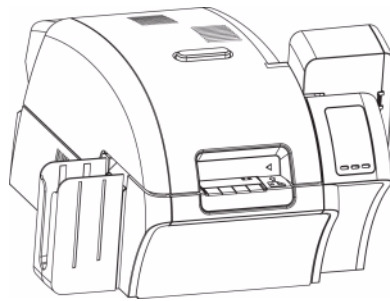

# Appendix F

---

## Packing the Printer for Shipment



### Introduction

If the printer is to be shipped, it is important to use the original packing and shipping material to prevent damage to the Printer.

If the original material is lost, a replacement Shipping Kit can be ordered from Zebra; see the Spare Part Kits listing in the Service Manual or check the *Partner Zone* on [www.zebracard.com](http://www.zebracard.com).

### Procedure



**Note** • The specifics of the shipment and the printer's condition may influence which of the following steps are followed; common sense should prevail.

- Step 1.** Remove any cards from the Input and Output Hoppers.
- Step 2.** If the printer still has power applied and is turned on and is still connected to the host computer, set the printer's power switch (on the back of the printer) to the OFF (○) position; and disconnect the interface and power cables to the printer.
- Step 3.** Open the printer Door.
- Step 4.** Remove the Print Ribbon and Transfer Film. (If you wish to save the print ribbon and film for future use, you may want to put them in a plastic bag for storage.)
- Step 5.** Remove the Card Cleaning Cartridge and Card Cleaning Roller, and place them in the foam insert.
- Step 6.** Close the printer Door.

## Packing the Printer for Shipment

**Step 7.** Remove the Input and Output Hopper, and place them in the foam insert.



**Note •** In the figure below, the printer and accessories are shown in the bottom foam insert, out of the shipping carton for clarity.

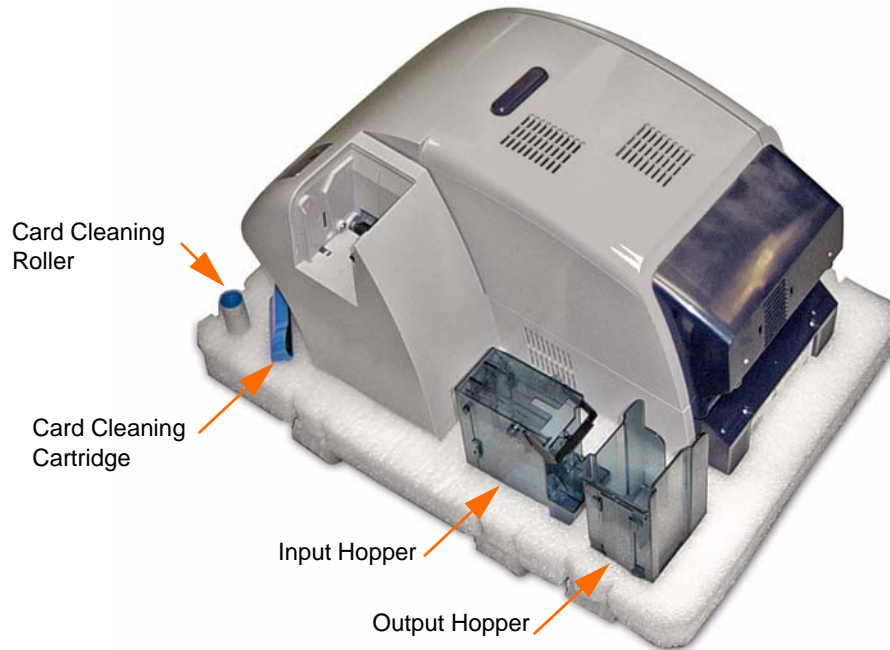

**Step 8.** Place the Printer in its protective plastic bag.

**Step 9.** Place the lower foam insert in the Shipping Carton.

**Step 10.** Use both hands to carefully place the Printer into the recess in the lower foam insert.

**Step 11.** Place the upper foam insert onto the Printer, and gently press it down so it makes a snug fit on the Printer -- the top of the upper foam insert should be even with the upper edge of the Shipping Carton.

**Step 12.** Close the Shipping Carton.

**Step 13.** Tape the Shipping Carton securely.

# APPENDIX G



---

## Worldwide Support

For Technical Support or Repair Services, contact the appropriate facility listed below.

### **North America and Latin America - Technical Support**

Phone: +1 877 ASK ZEBRA (877 275 9327)  
+1 847 913 2259  
email: [ts1@zebra.com](mailto:ts1@zebra.com)

### **North America and Latin America - Repair Services**

Before returning any equipment to Zebra Technologies Corporation for in-warranty or out-of-warranty repair, contact Repair Services for a Repair Order (RO) number. Mark the RO number clearly on the outside of the box. Ship the equipment, freight prepaid, to the address listed below:

Zebra Technologies Repair Services  
333 Corporate Woods Parkway  
Vernon Hills, IL 60061

webform: [www.zebra.com/repair](http://www.zebra.com/repair)  
Phone: 1-877-275-9327  
email: [repair@zebra.com](mailto:repair@zebra.com)

## Europe, Middle East, and Africa - Technical Support

Language	Phone	Email
German	+49 (0) 2159 676 870	zebratechDE@zebra.com
French	+33 (0) 1 53 48 12 74	zebratechFR@zebra.com
English	+44 (0) 1628 556 225	zebratechUK@zebra.com

### For further assistance, contact:

Zebra Technologies Card Printer Solutions  
 Dukes Meadow  
 Millboard Road, Bourne End  
 Buckinghamshire SL8 5XF, UK

Phone: +44 (0) 1628 556 025  
 FAX: +44 (0) 1628 556 001  
 e-mail: cardts@zebra.com

## Europe, Middle East, and Africa - Repair Services

Before returning any equipment to Zebra Technologies Corporation for in-warranty or out-of-warranty repair, contact your supplier for a Return Materials Authorization (RMA) number, or contact one of the following repair centers for support and instructions:

Type of repair and location	Phone	Email
Depot Repair in Germany, Austria, Switzerland	+49 (0) 2159 676 870	zebracareDE@zebra.com
Depot Repair in France	+33 (0) 1 53 48 12 74	zebracareFR@zebra.com
Depot and On-Site Repair in UK and Ireland	+44 (0) 1628 556 225	zebracareUK@zebra.com
Depot Repair in South Africa	+27 (0) 11 201 7777	-
Depot Repair in the Middle East	+971 (0) 46058220	support_dxb@emitac.ae

### For further assistance, contact:

For assistance anywhere in the EMEA, contact After Sales Customer Services at:

Phone: + 44 (0) 177 2 69 3069  
 email: ukrma@zebra.com



## Asia Pacific - Technical Support

Zebra Technologies Asia Pacific Pte. Ltd.  
120 Robinson Road  
#06-01 Parakou Building  
Singapore 068913

Phone: +65 6858 0722  
Fax: +65 6885 0838  
Email: [tsasiapacific@zebra.com](mailto:tsasiapacific@zebra.com)

## Asia Pacific - Repair Services

Before returning any equipment to Zebra Technologies Corporation for in-warranty or out-of-warranty repair, contact Repair Services for a Return Materials Authorization (RMA) number. Repack the equipment in the original packing material, and mark the RMA number clearly on the outside. Ship the equipment, freight prepaid, to either address listed below:

Zebra Technologies Asia Pacific Pte. Ltd.  
No.5 Changi North Way Level 3  
Singapore 498771  
Agility Building

Phone: +65 6546 2670 ext 3203 and 3204  
Fax: +65 6546 5328  
Email: [APACRepair@zebra.com](mailto:APACRepair@zebra.com)

## Zebra Website

[www.zebracard.com](http://www.zebracard.com)

